

memória flutuante

COMPLEXO CULTURAL,
AMBIENTAL E CIENTIFICO
ILHA DA CASA DA POLVORA

Trabalho de Conclusão de Curso
Faculdade de Arquitetura e Urbanismo UFRGS
2019.02

Orientador
Nicolás Sica Palermo

Acadêmica
Mariana Rodrigues Samurio



Situação Ambiental do Brasil



59,05% do Brasil é área de floresta

Fontes:
www.fao.org/forest-resources-assessment/en
www.fao.org/3/a-az172e.pdf;
Resolução n 1 de 15/01/2013 do IBGE

■ Área de vegetação florestal (2000)
■ Área de vegetação desmatada (2000-2016)

Situação Ambiental do Brasil

biomas brasileiros remanescentes

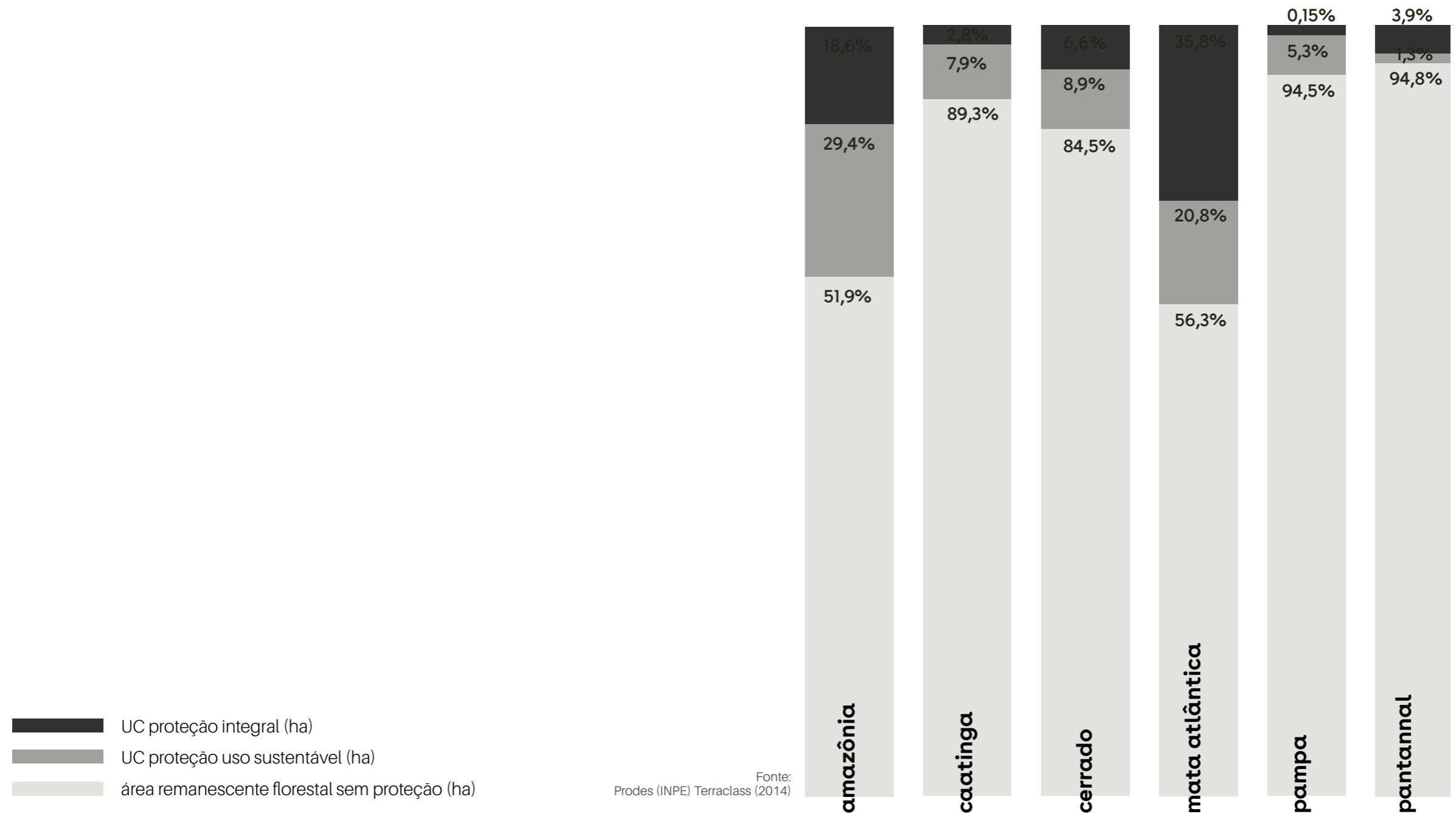

Fonte:
Prodes (INPE) Terraclass (2014)

Situação Ambiental do Brasil

desmatamento do pampa e da mata atlântica no brasil

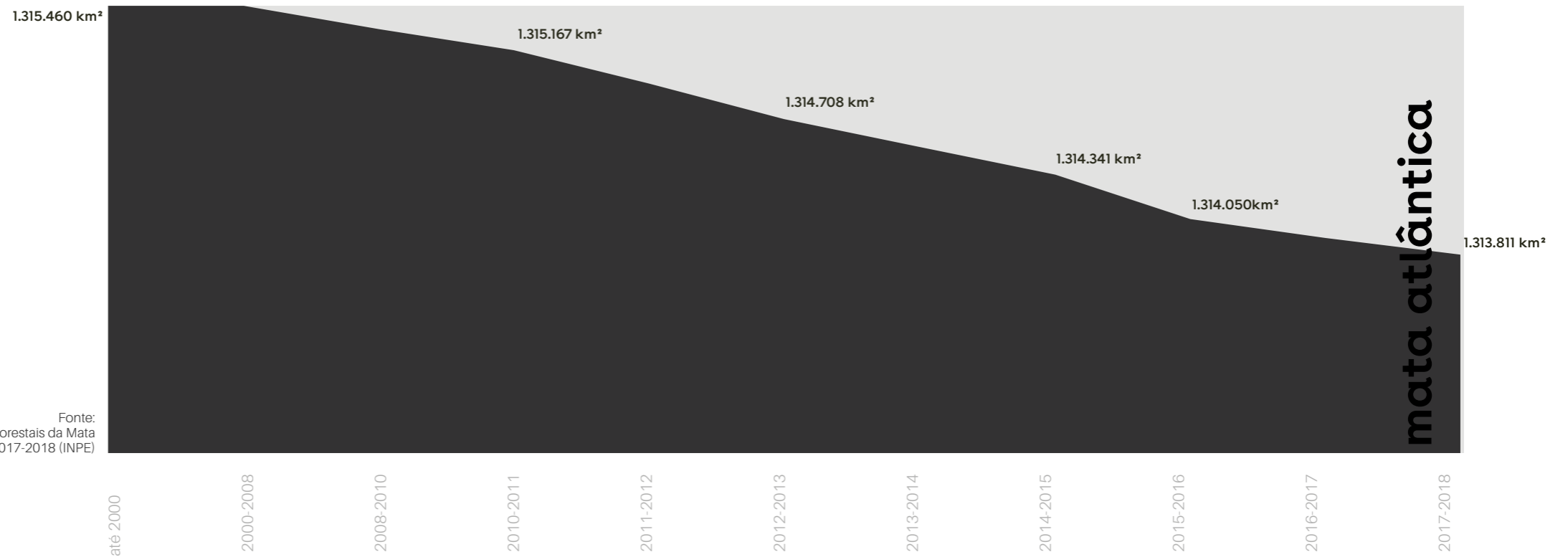
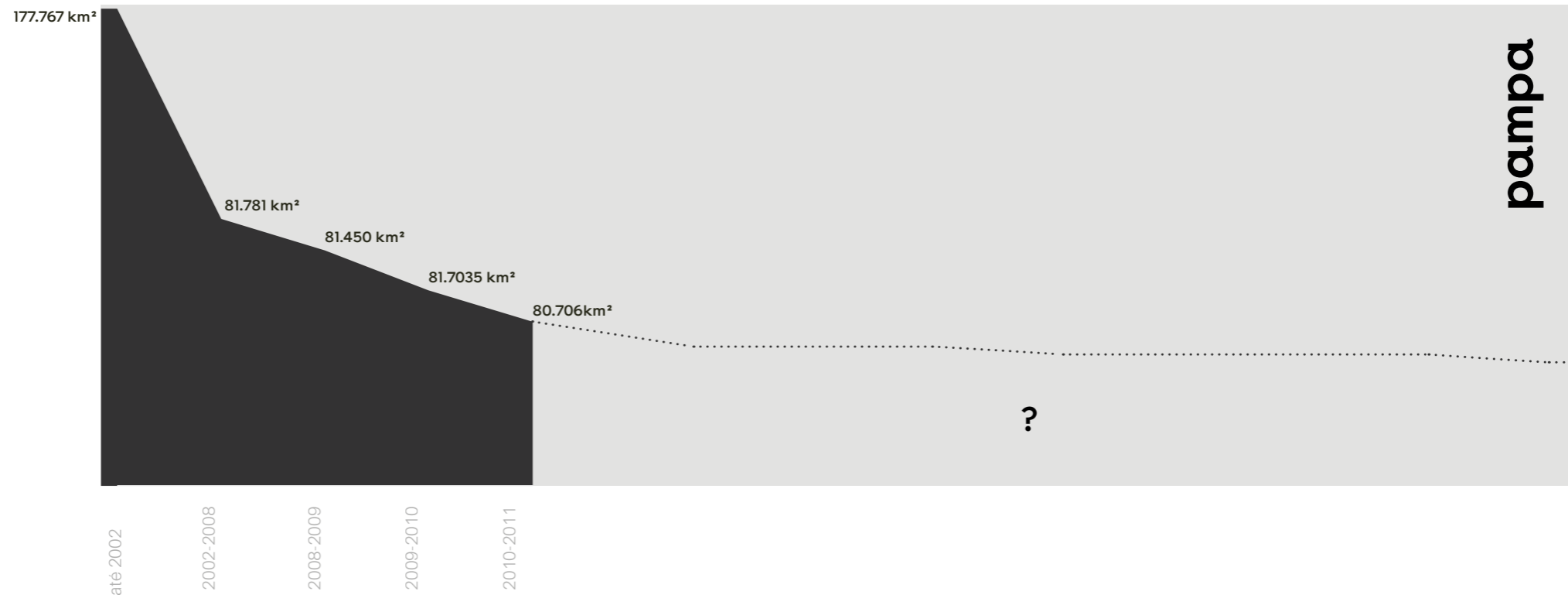

Fonte:
Atlas dos Remanescentes Florestais da Mata
Atlântica 2017-2018 (INPE)

Situação Ambiental do RS

**APENAS 2% DAS ÁREAS DE FLORESTAS
SÃO PROTEGIDAS POR UCs NO RS**

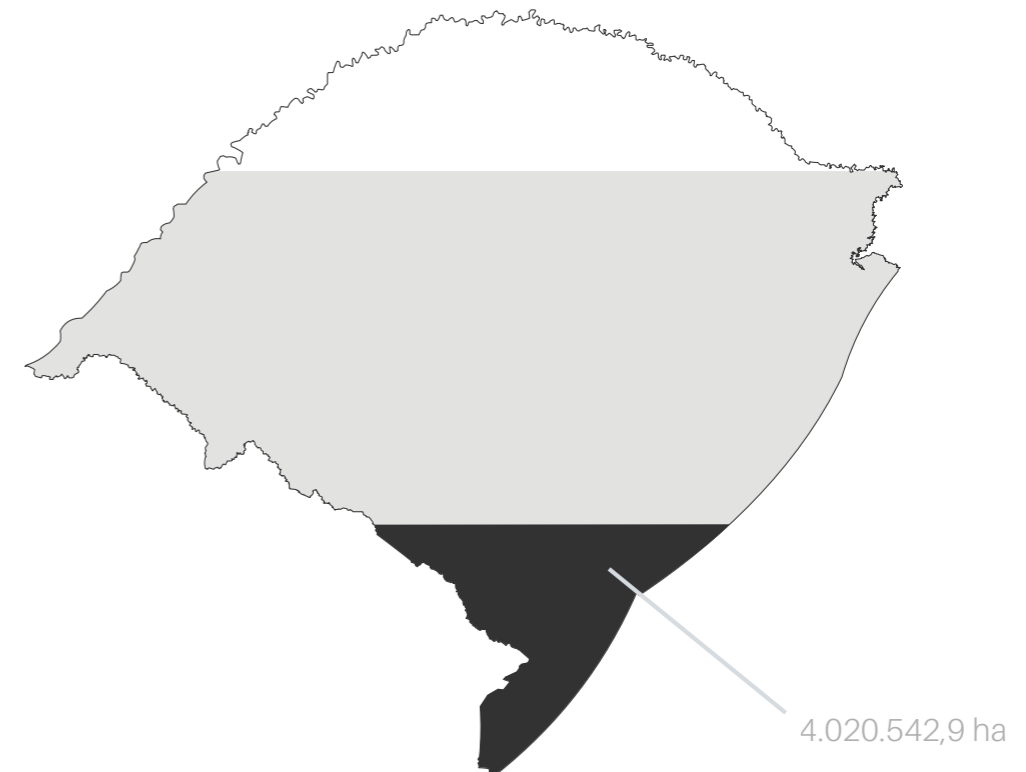

15% do RS é área de floresta

Fontes:
<http://www.florestal.gov.br/>

- Área de vegetação florestal (2018)
- Área de vegetação desmatada (2000-2016)

Situação Ambiental do RS

desmatamento da mata atlântica no RS

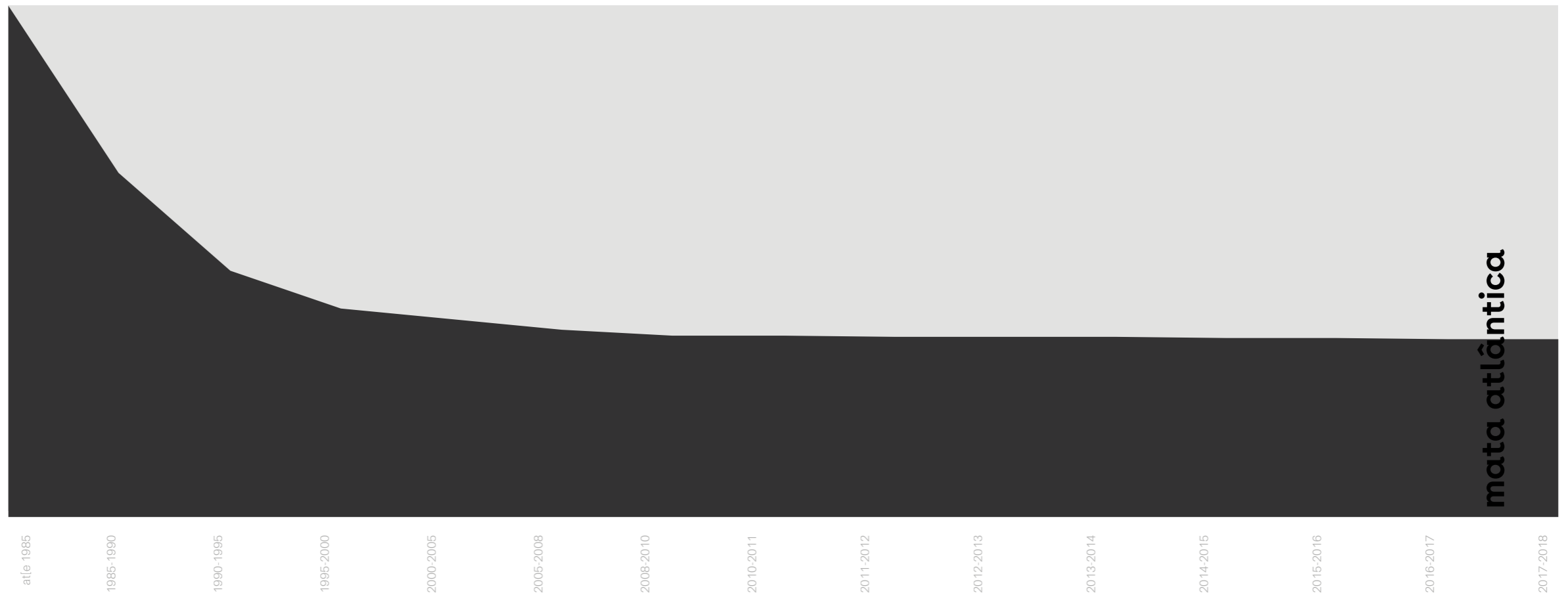

Fonte: SERVIÇO FLORESTAL BRASILEIRO. Inventário Florestal Nacional: principais resultados: Rio Grande do Sul. Brasília, DF: MMA, 2018. 83 p. (Série Relatórios Técnicos - IFN).

A cidade sobre o rio



O rio sobre a cidade



Este trabalho busca promover a preservação de uma das maiores áreas naturais da região metropolitana de Porto Alegre: o Delta do Jacuí.

Para isso, propõe-se a criação de um um ponto turístico com vocação ambiental-educativa na Ilha da Casa da Pólvora.

vivenciar

vivenciar

aprender

vivenciar

aprender

conservar

Delta do Jacuí

localização na RMPA



Ilha da Casa da Pólvora

breve histórico



Ilha da Casa da Pólvora

pré existências

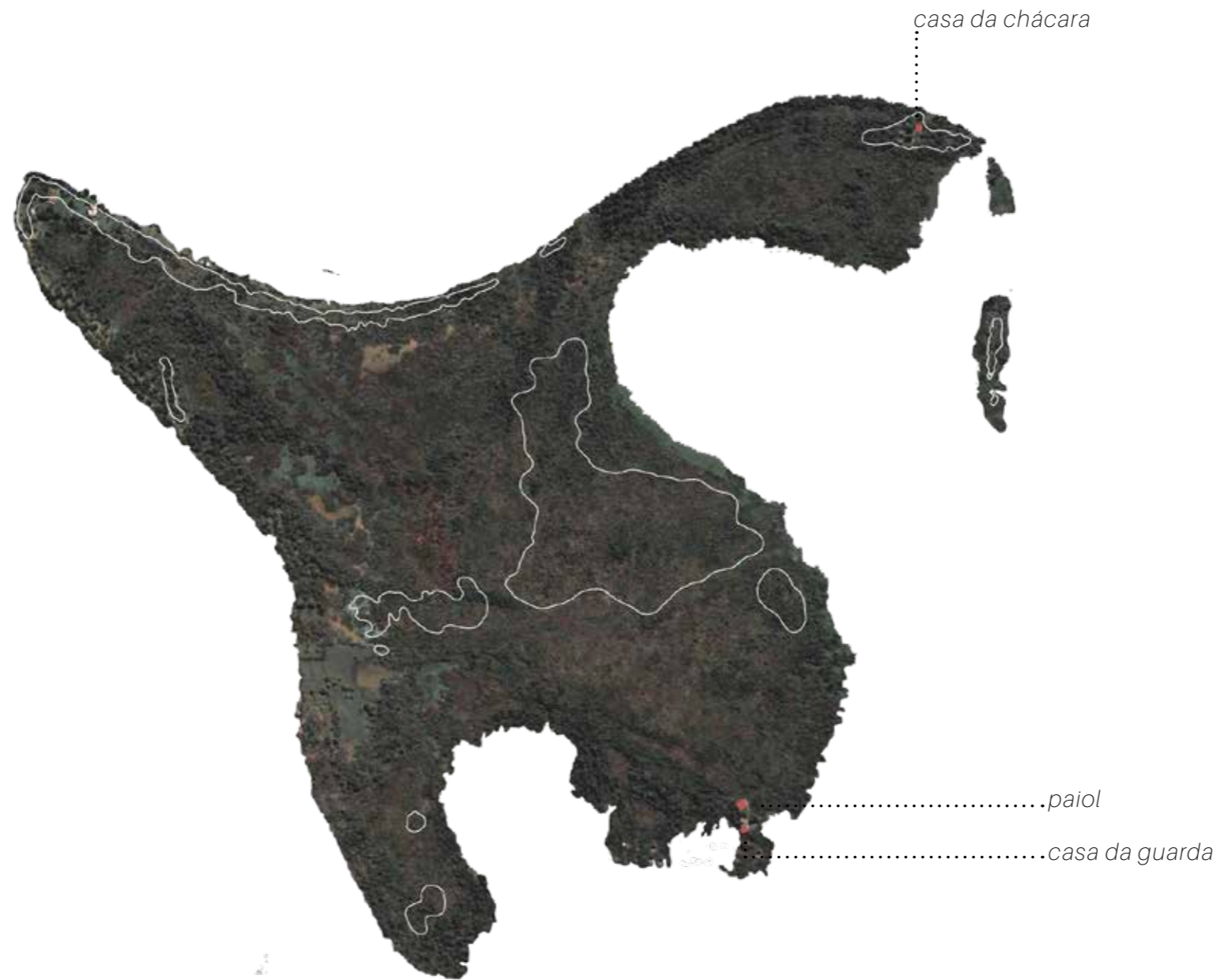

Ilha da Casa da Pólvora

pré existências



Paiol
histórico

antes do restauro



1999

após restauro



1996

atualmente



2019

Paiol
levantamento

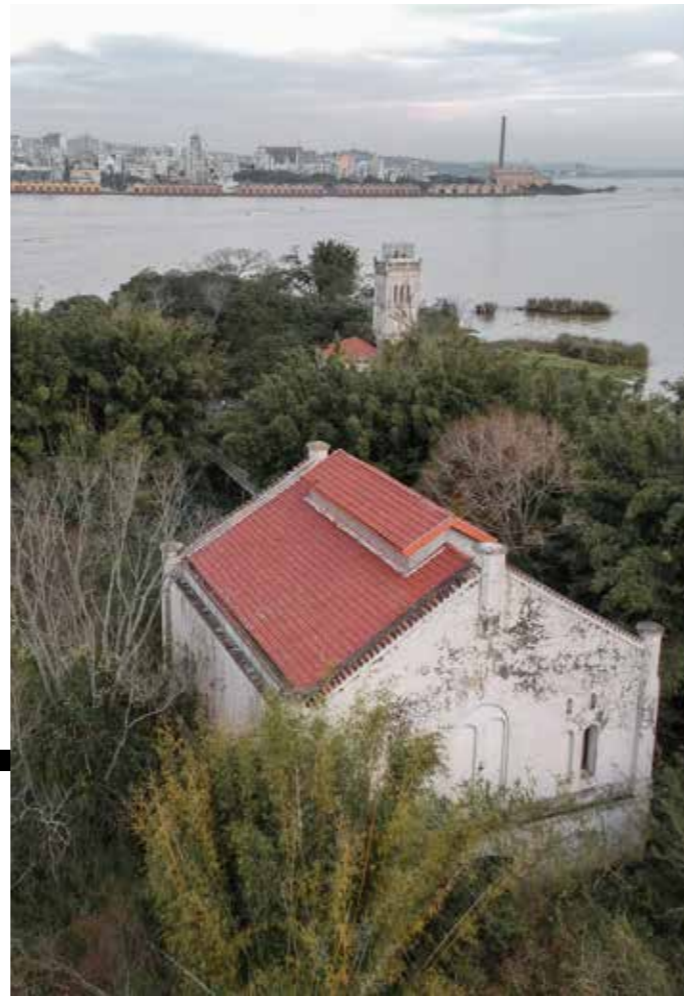
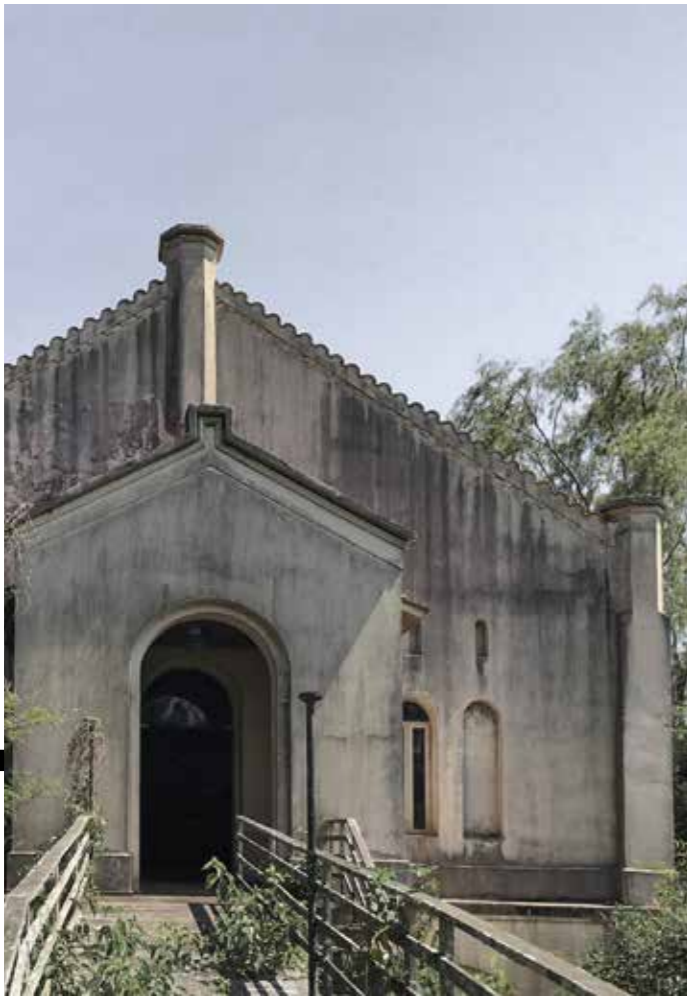

Casa da Guarda

histórico

antes do restauro



1999

após restauro



1996



atualmente

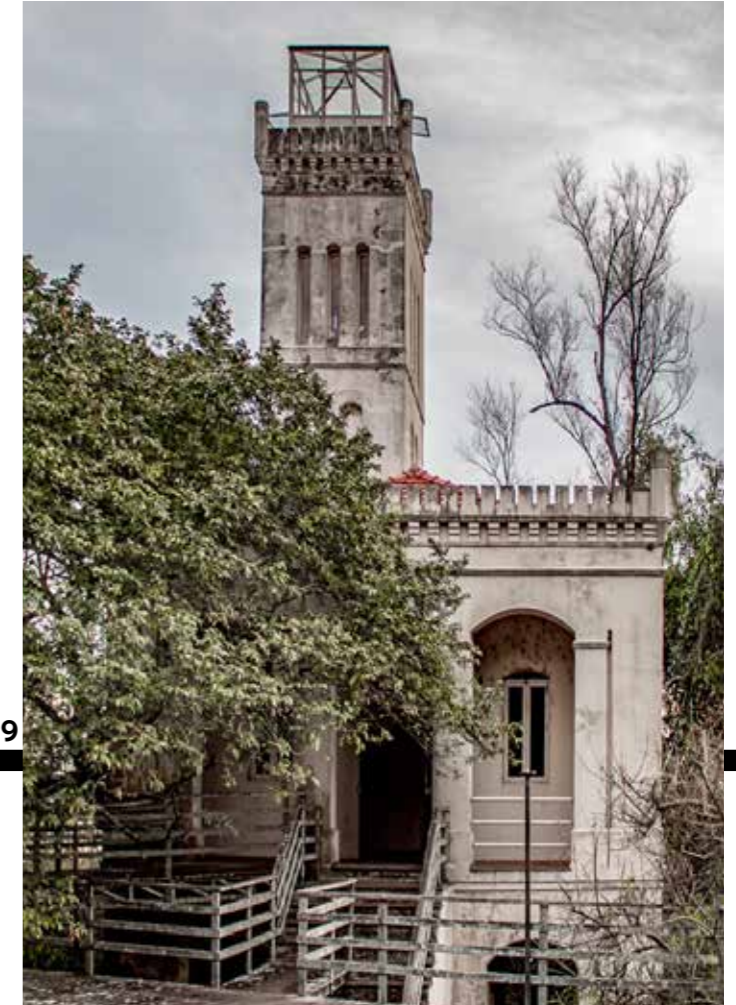

2019



Casa da Guarda

levantamento

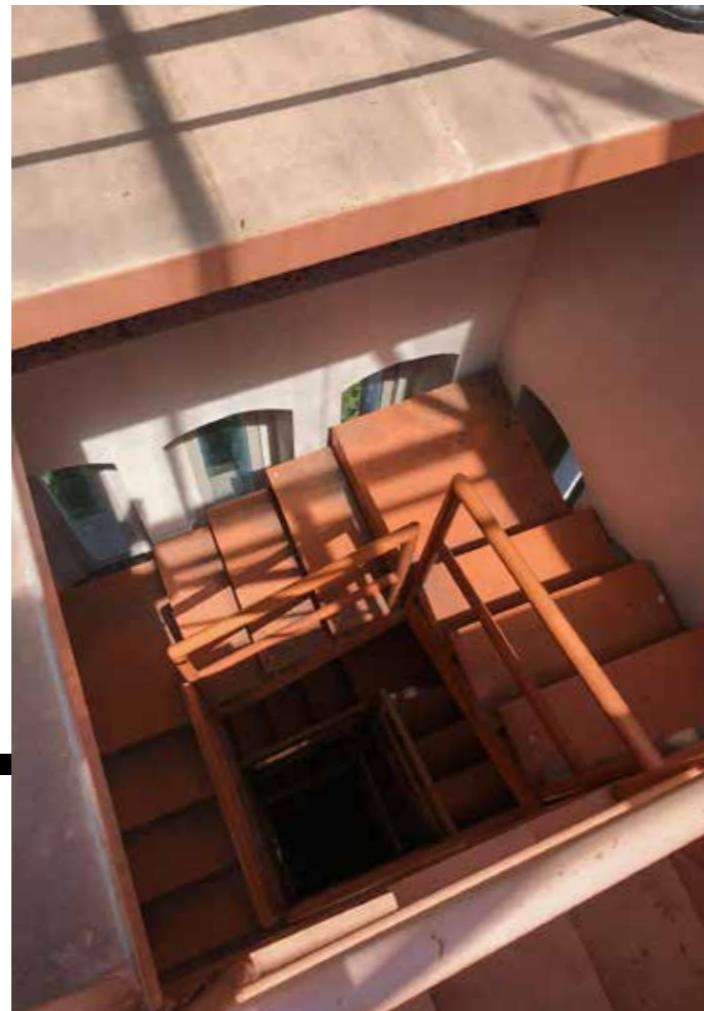

Casa da Chácara

histórico

atualmente



Plano de Manejo

zoneamento usos

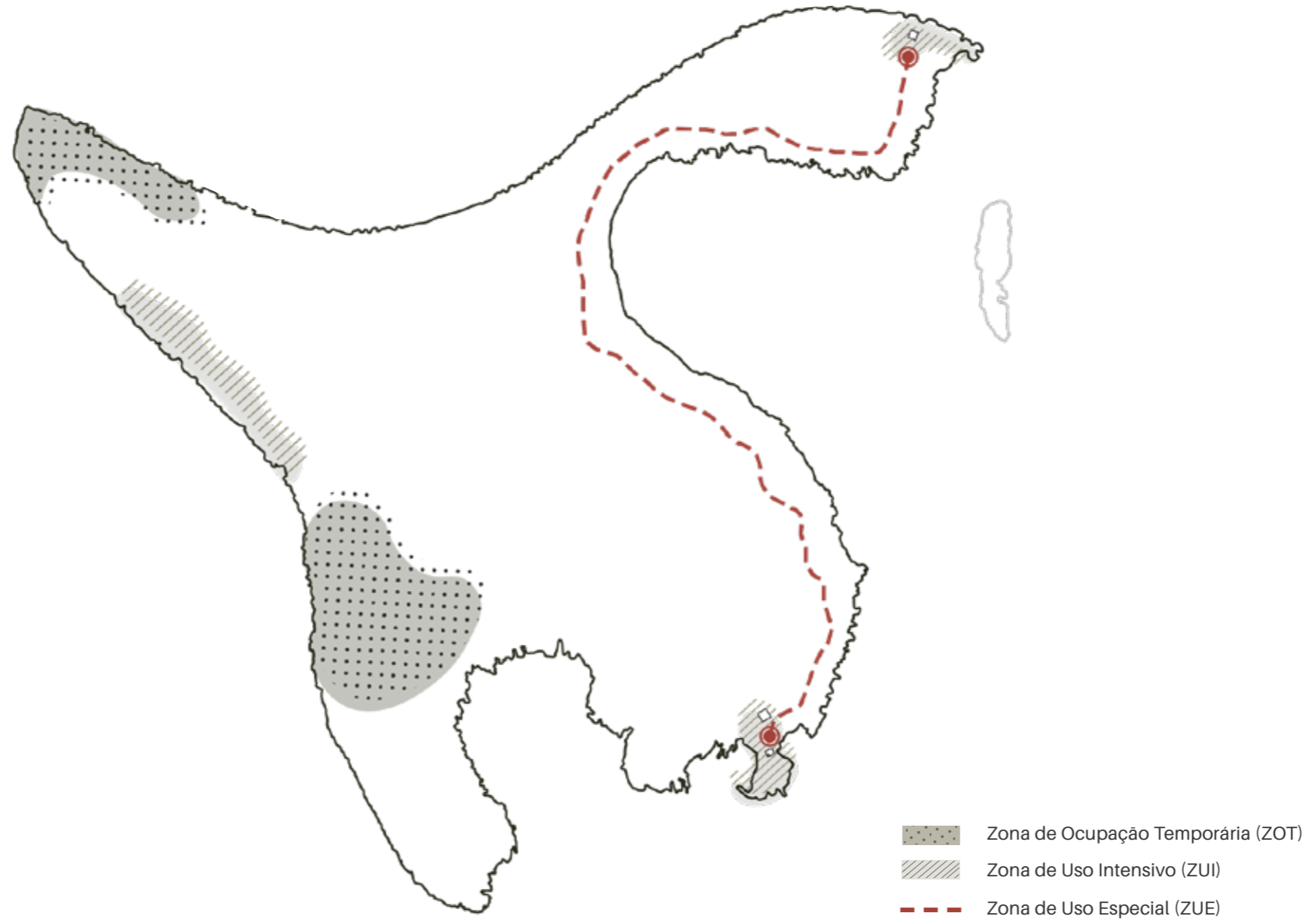

objetivo

criar um complexo cultural, ambiental e científico que resgata a proposta do antigo Ecomuseu proposto para a ilha, propondo a inserção de anexos para abrigar usos complementares, como centro de visitantes, auditório, laboratórios de pesquisa e áreas de lazer.

Programa
organograma





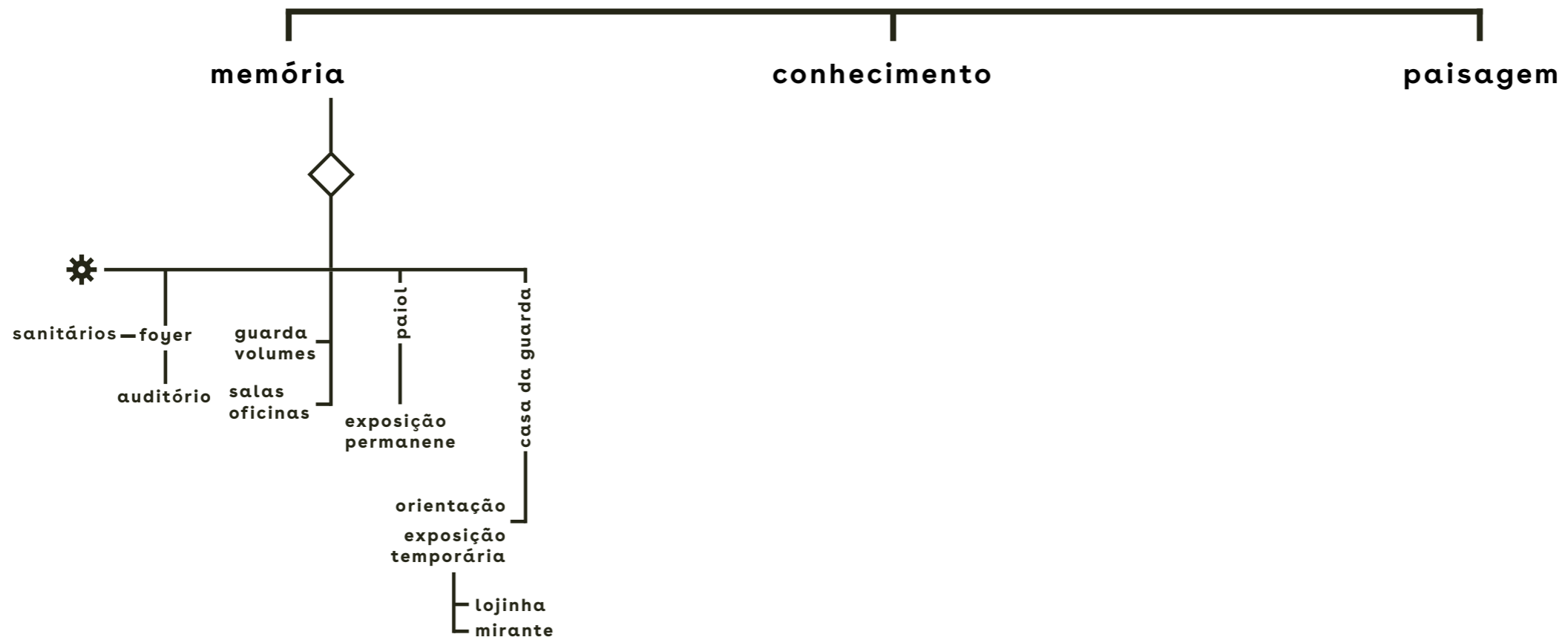

Programa

organograma



Legenda



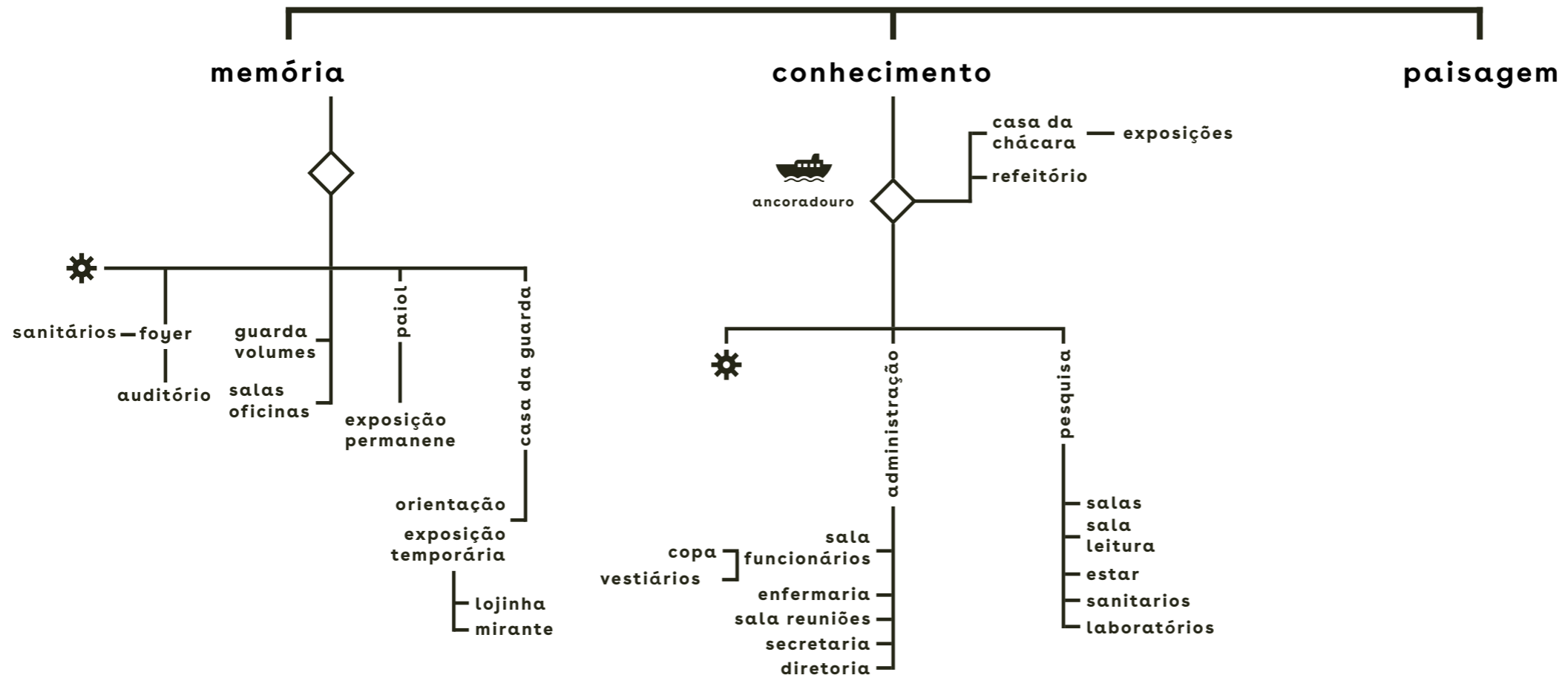

-  Infraestrutura
 - _reservatórios
 - _depósito lixo
 - _subestação
 - _gás
 - _manutenção
-  Praças
-  Mirante
-  Parada catamarã

Programa

organograma



Legenda



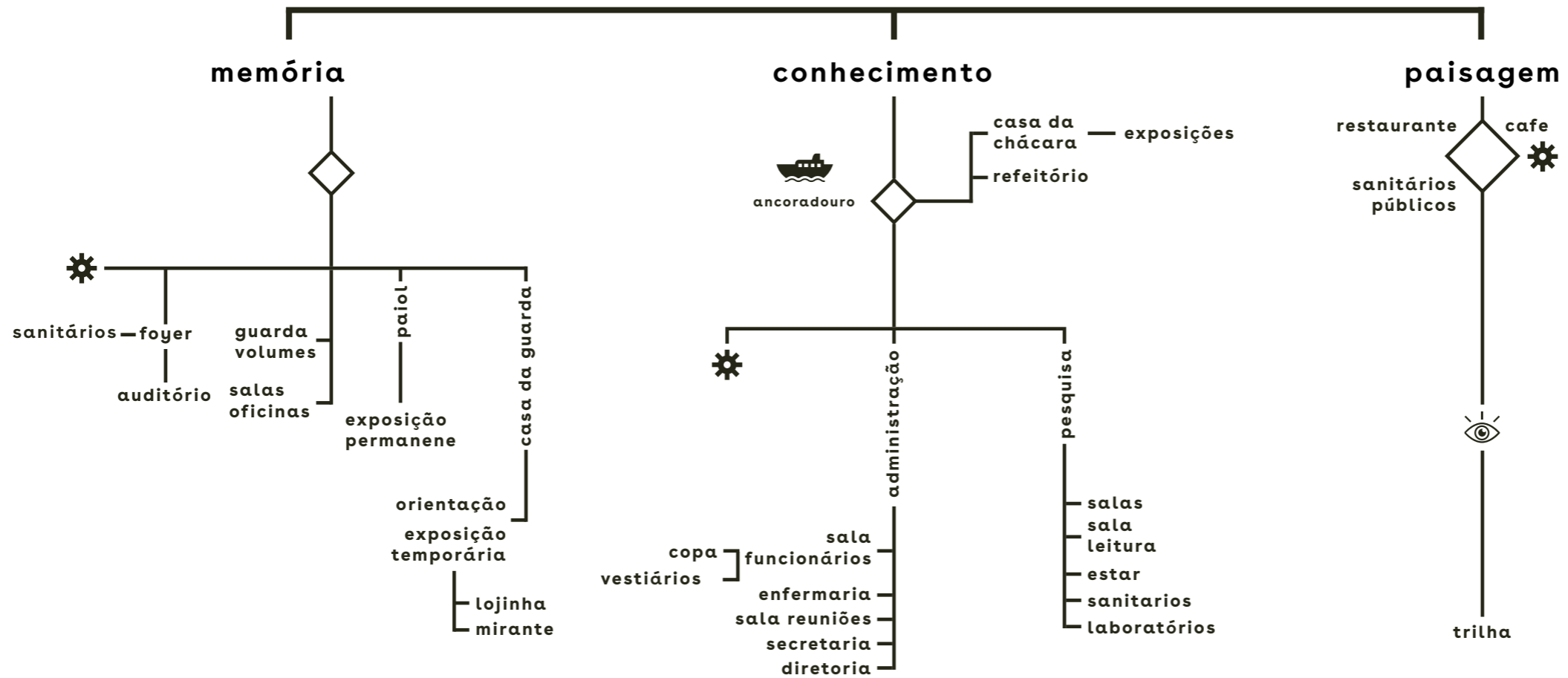

-  Infraestrutura
-  Praças
-  Mirante
-  Parada catamarã
- _reservatórios
- _depósito lixo
- _subestação
- _gás
- _manutenção

Programa

organograma



Legenda

-  Infraestrutura
 - _reservatórios
 - _depósito lixo
 - _subestação
 - _gás
 - _manutenção
-  Praças
-  Mirante
-  Parada catamarã

Partido Geral

03 temáticas

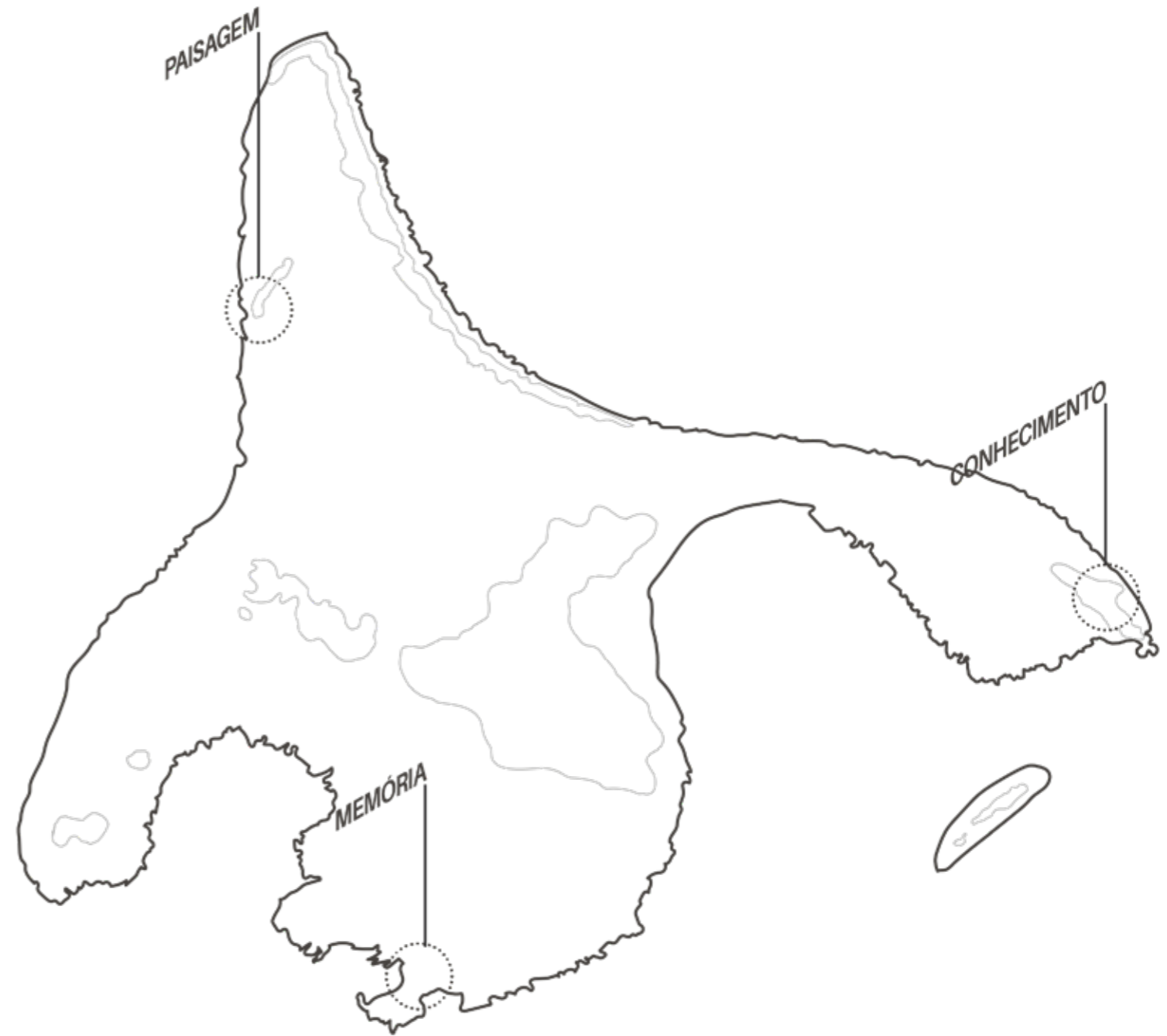

Partido Geral

ancoradouros



Partido Geral
trilhas suspensas

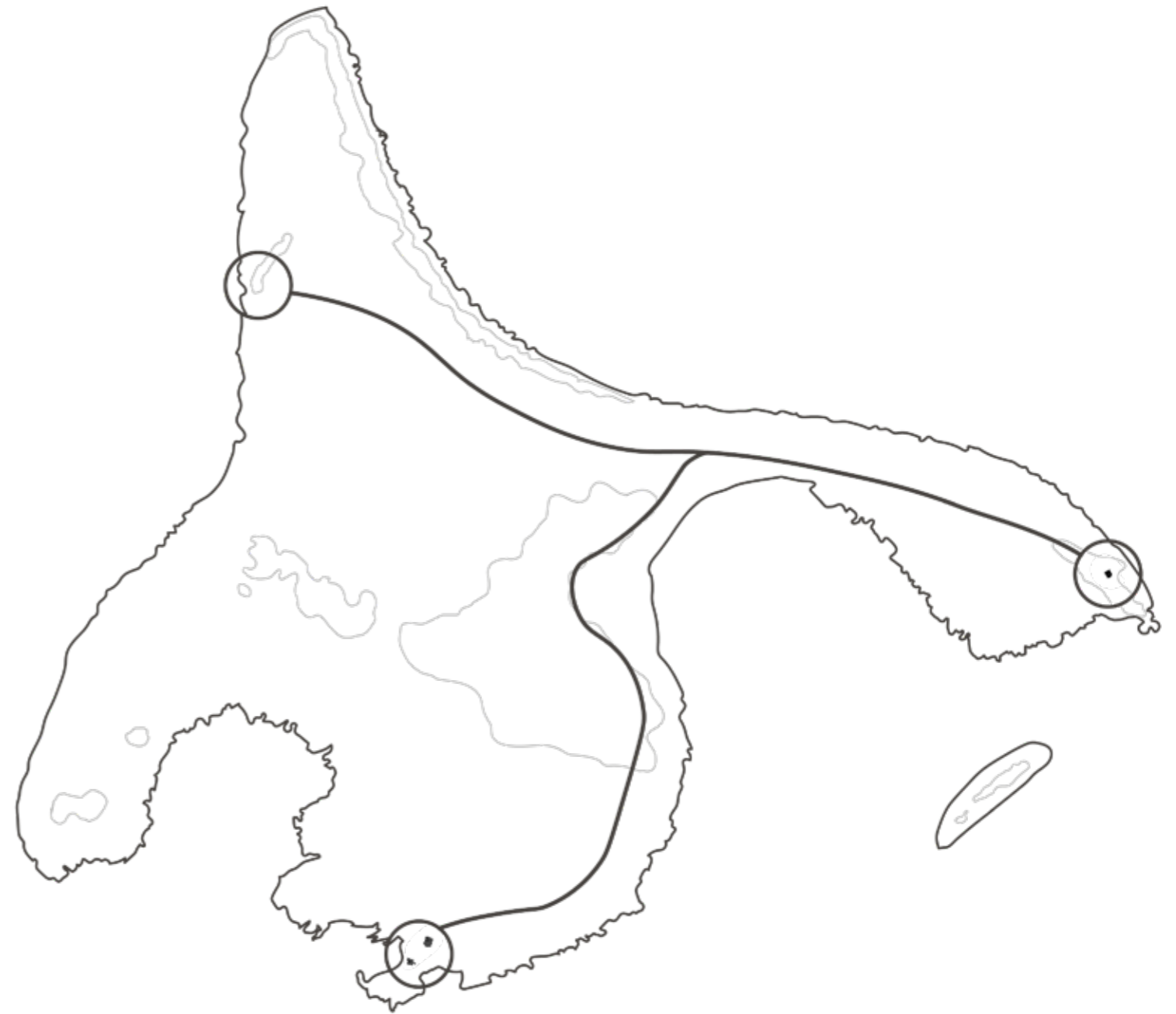

Partido Geral

mirante

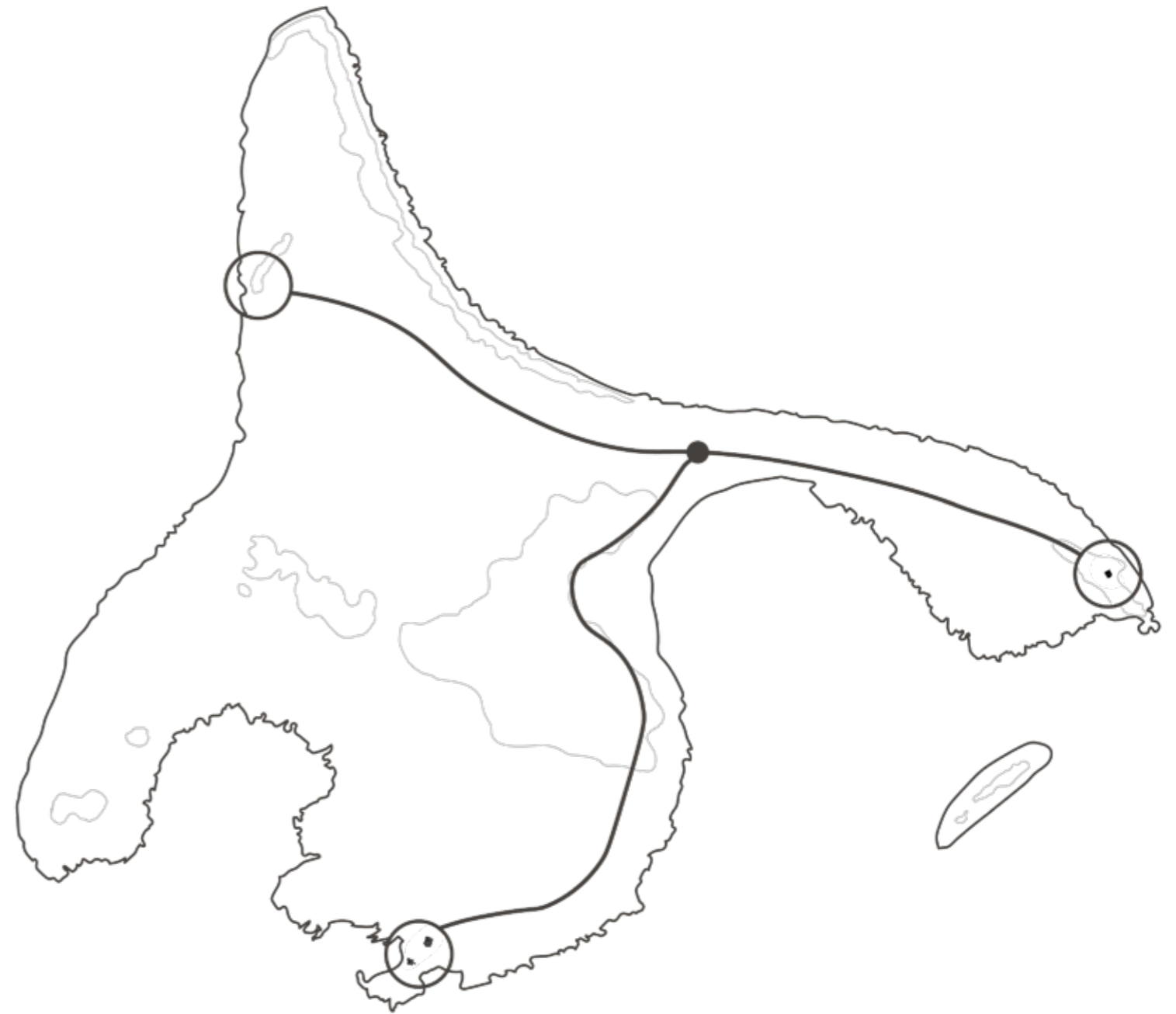

Partido Geral

Implantação



Memória

Partido Geral

Centro memória



Memória

edificações existentes

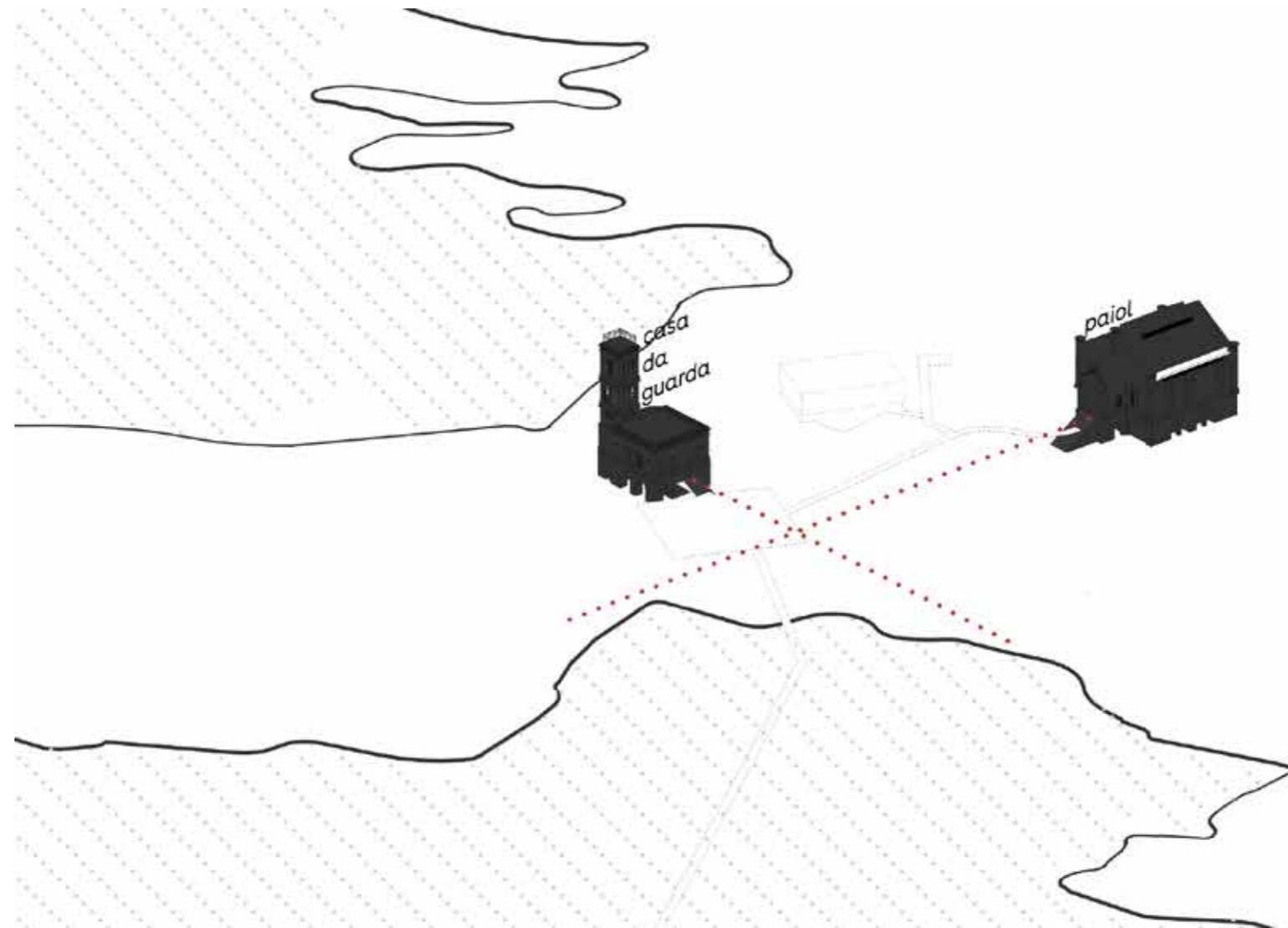

Memória

posicionamento do programa

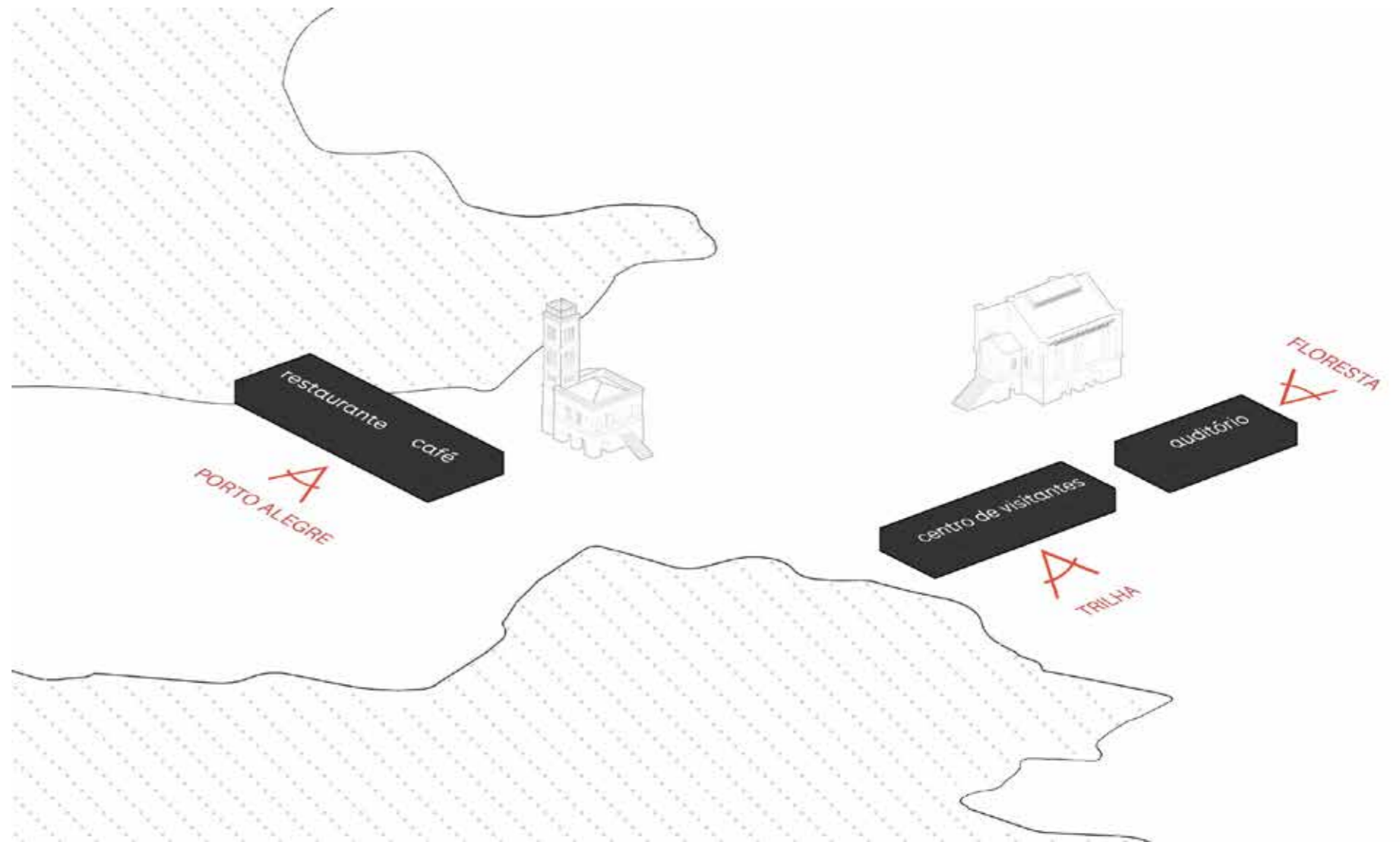

Memória

praça que organiza

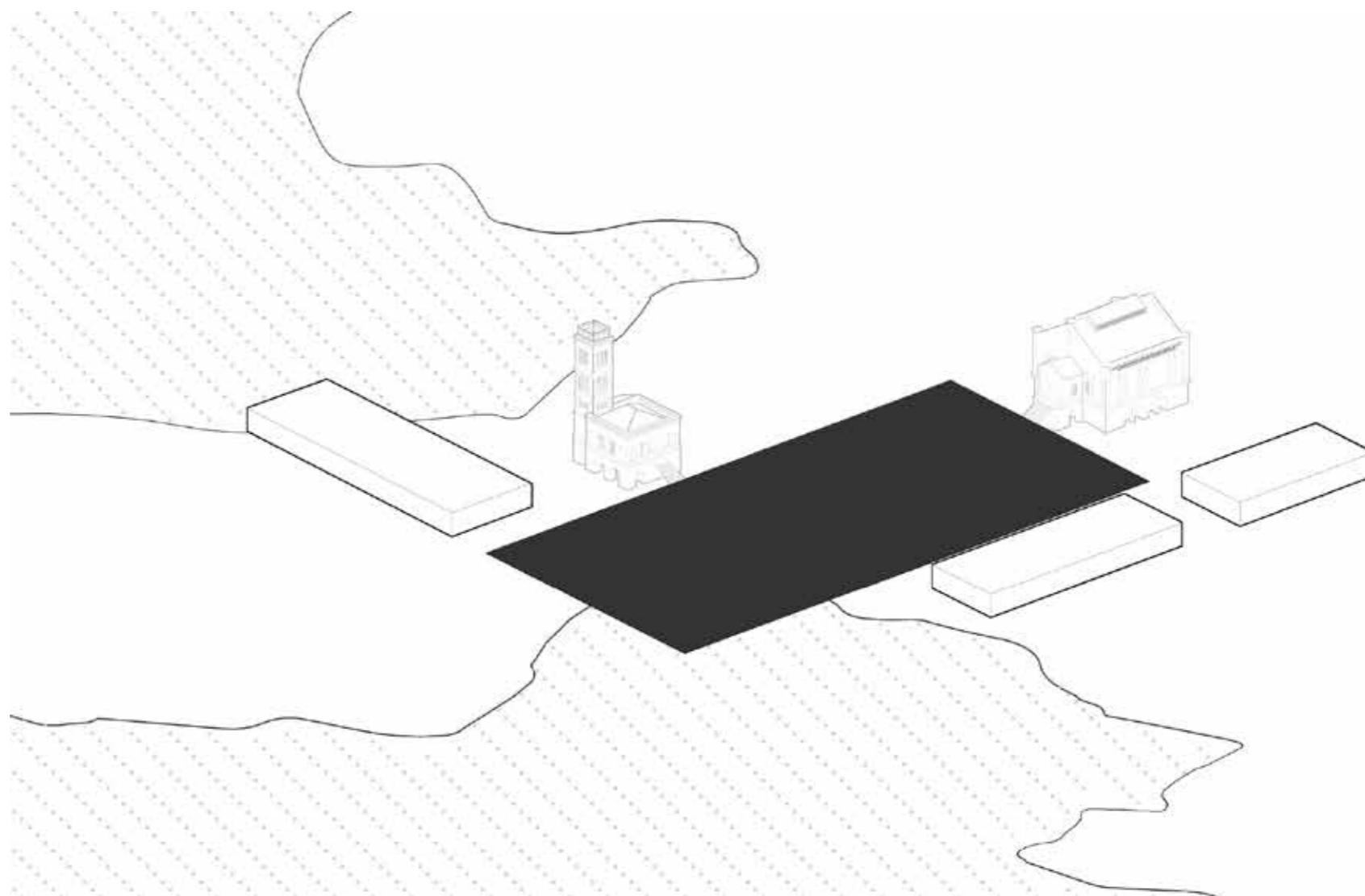

Memória

subtrações

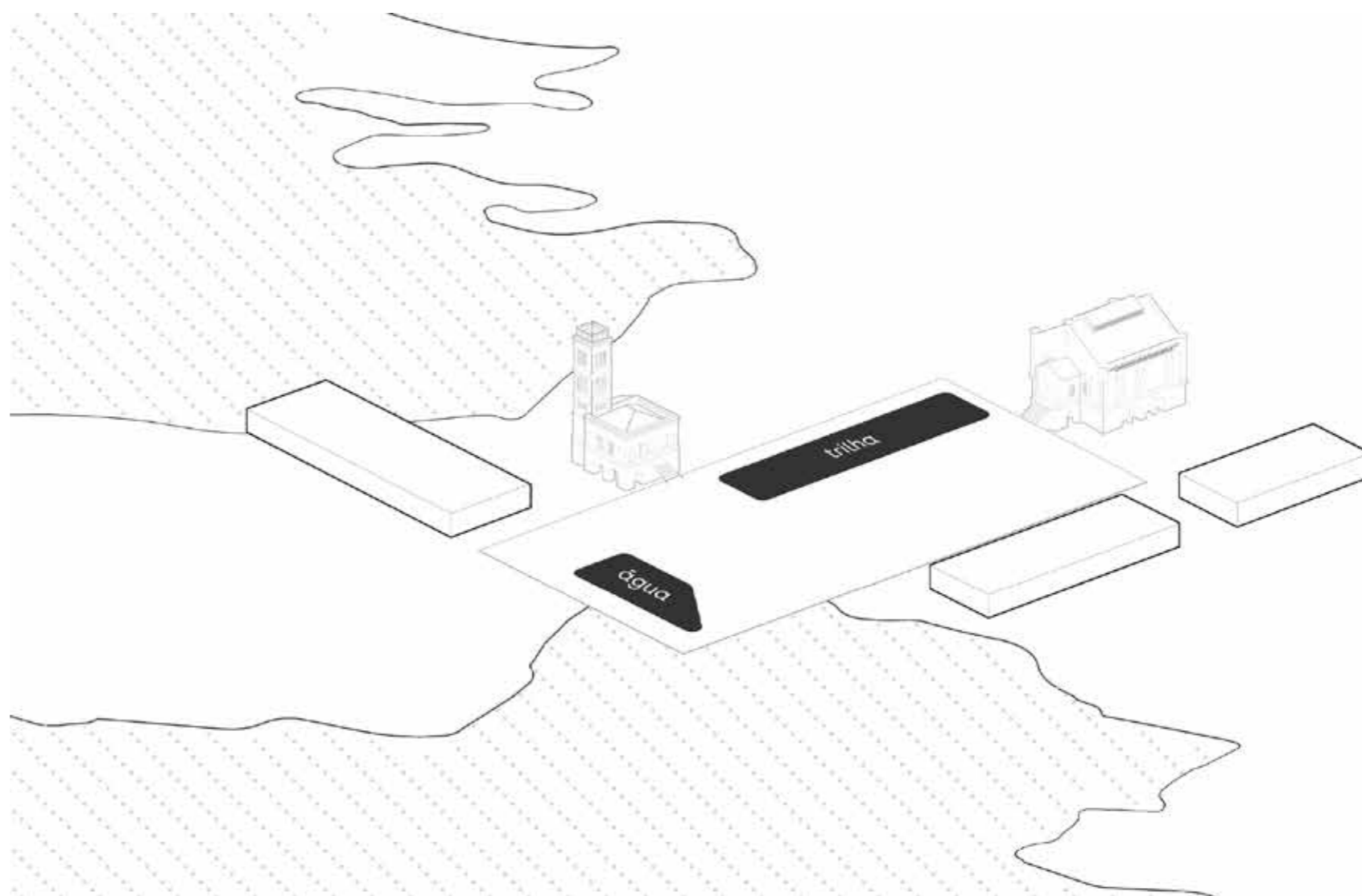

Memória

subtrações

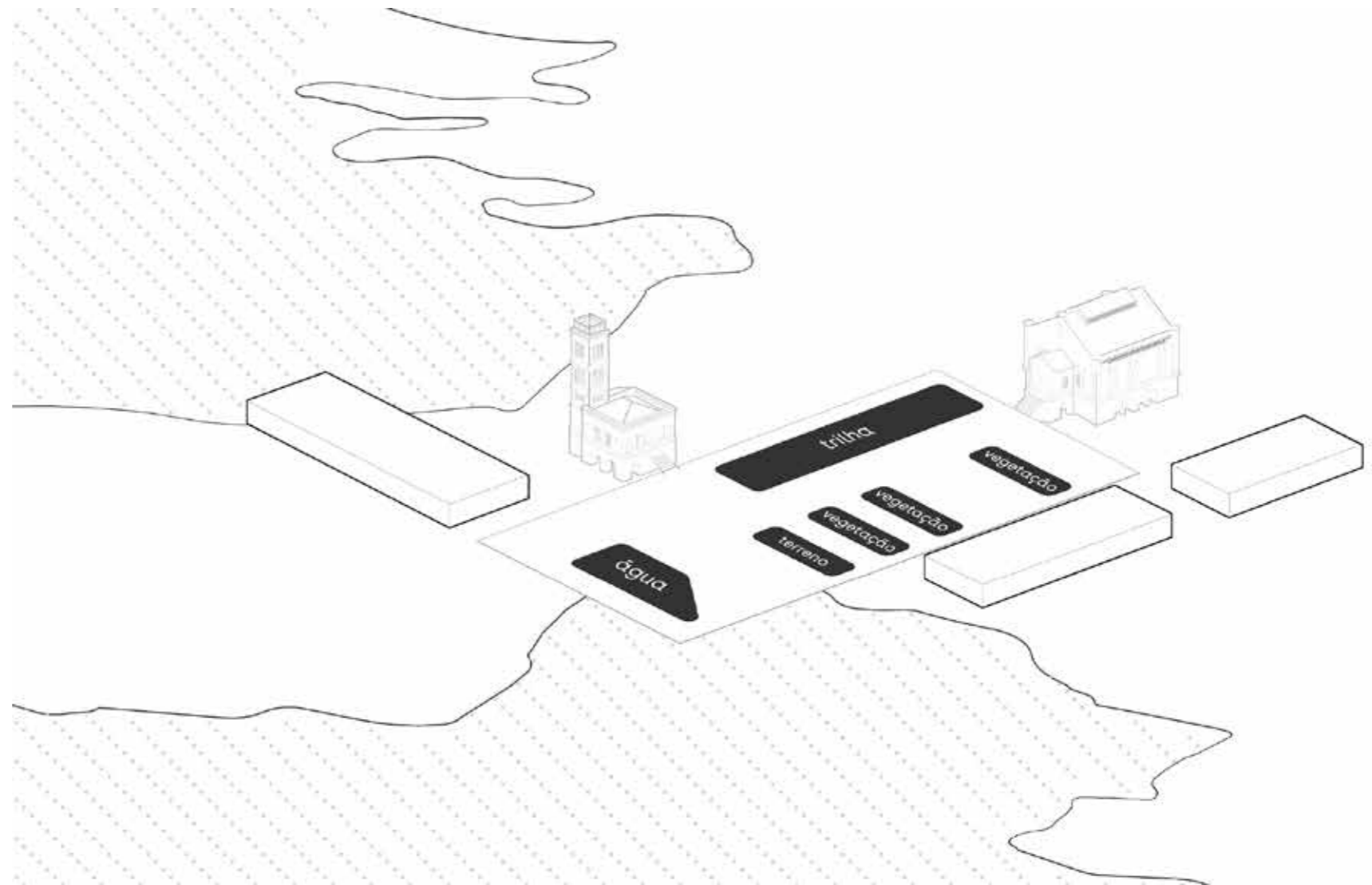

Memória

implantação

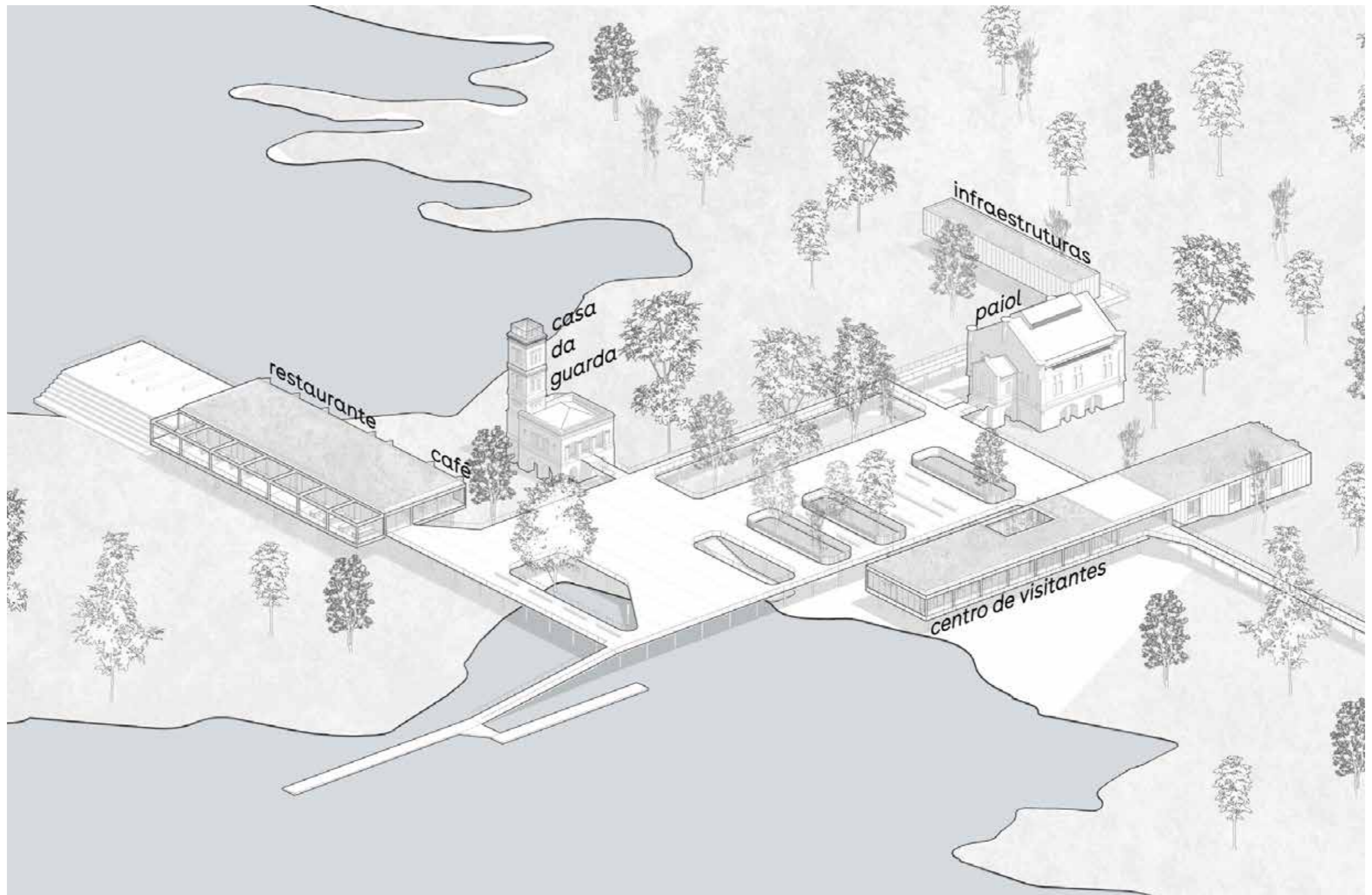

Memória

planta baixa

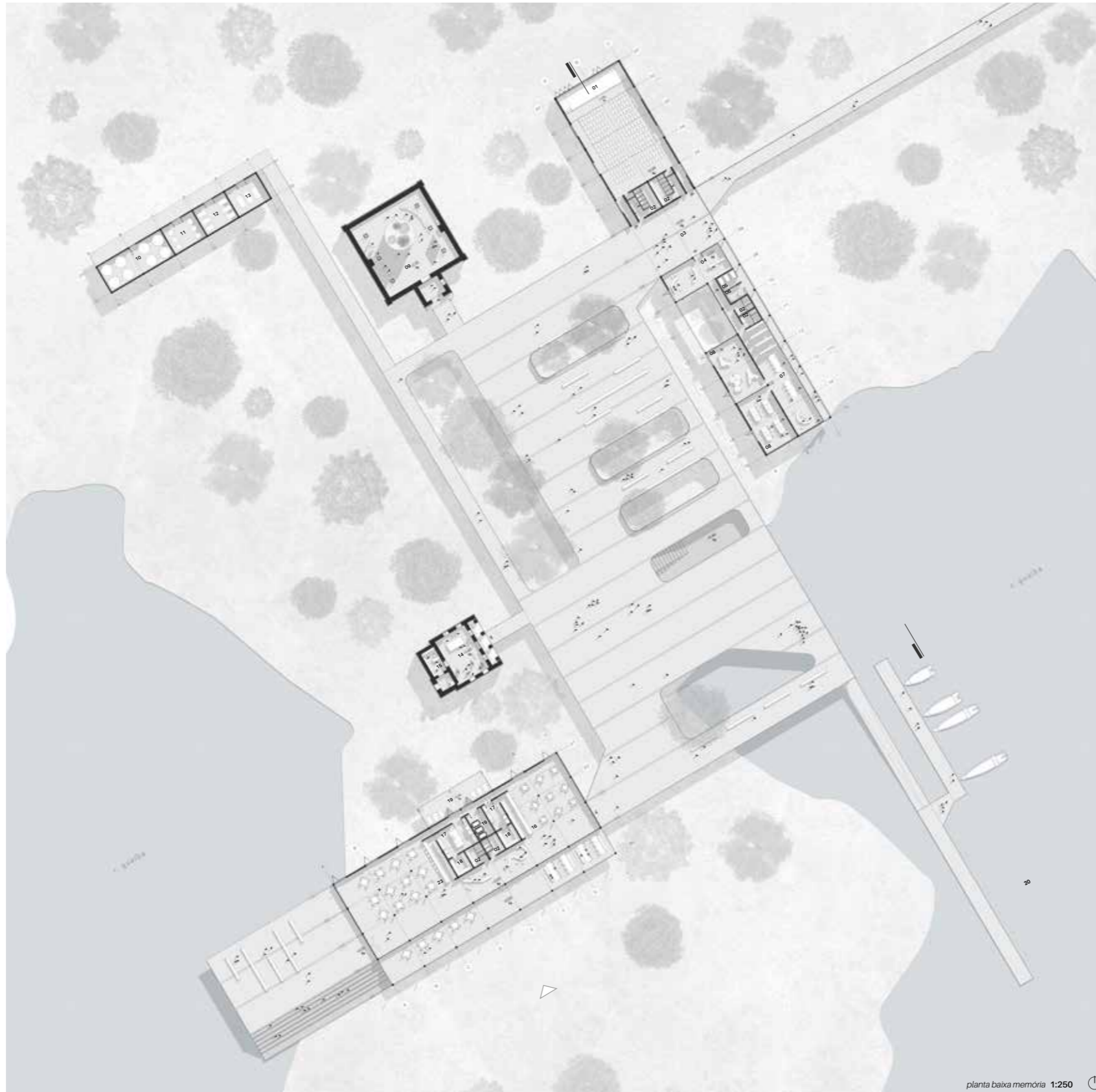

planta baixa memória 1:250

Memória

auditório
centro de visitantes



planta baixa memória 1:250

Memória

auditório
centro de visitantes

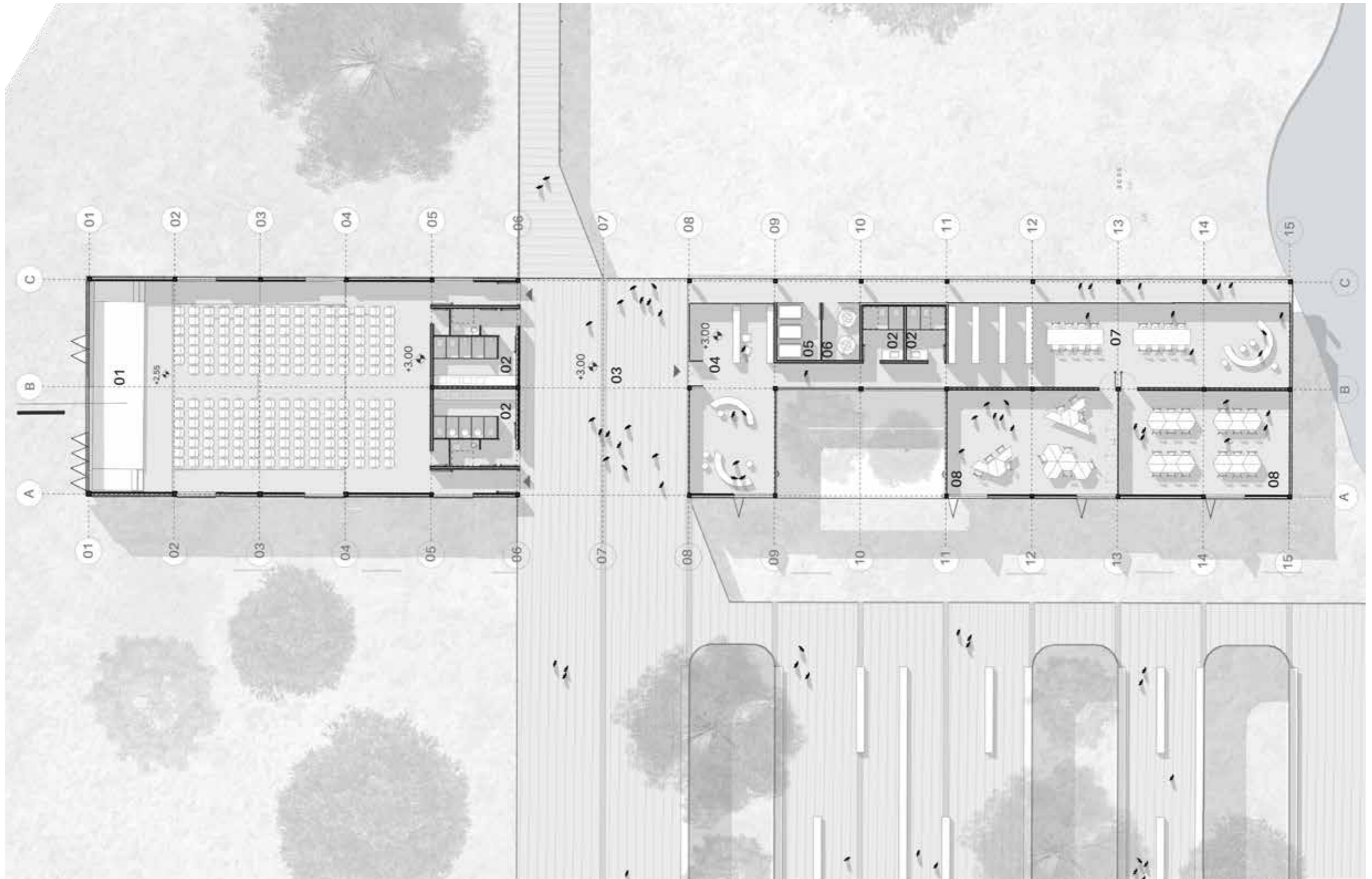

Memória

auditório



Memória

recepção



Memória

área técnica



Memória

salas multiuso



Memória

área de leitura e estar



Memória

auditório
centro de visitantes

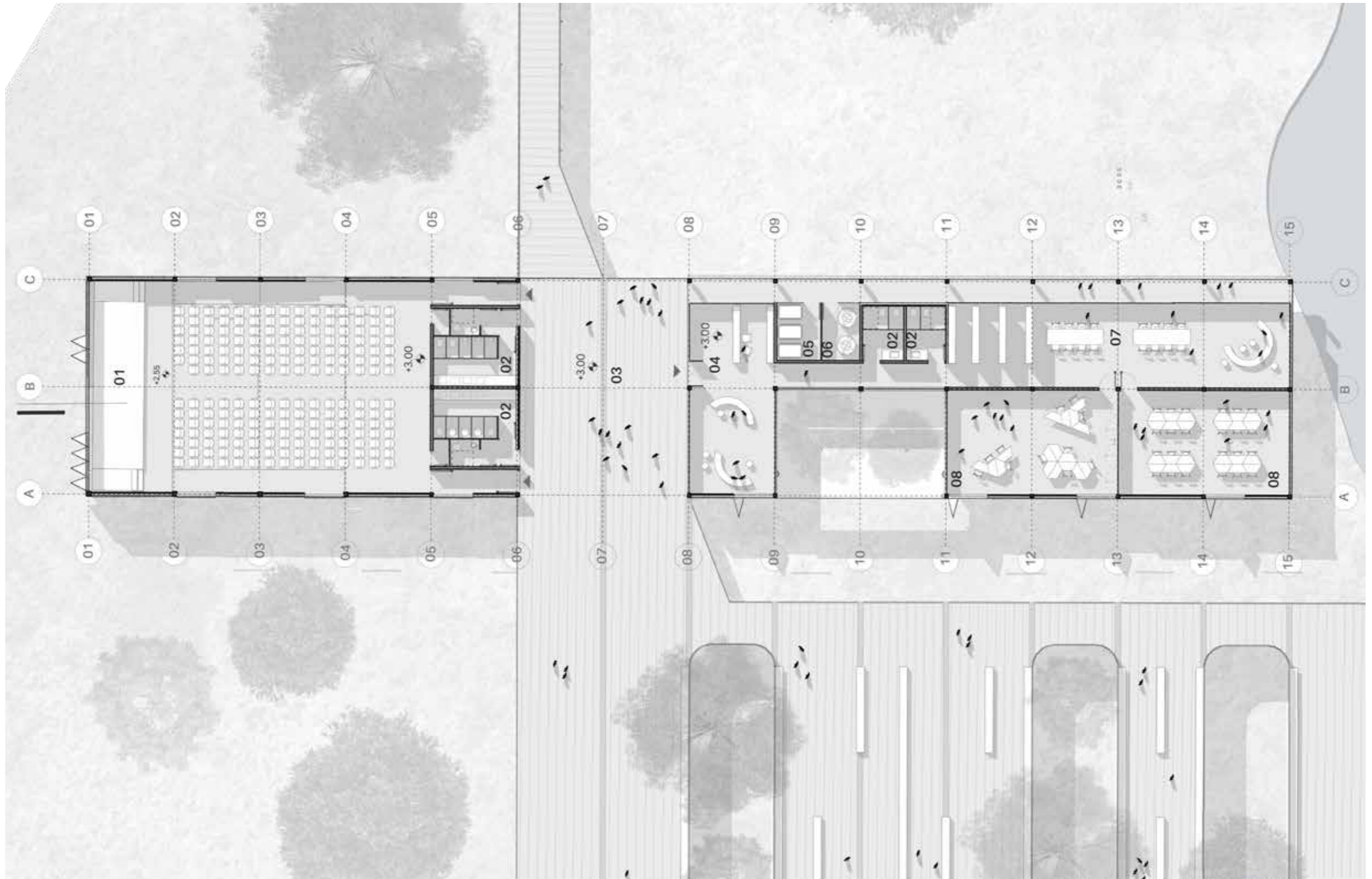

Memória

Paiol:
exposição permanente



planta baixa memória 1:250

Memória

Paiol:
exposição permanente

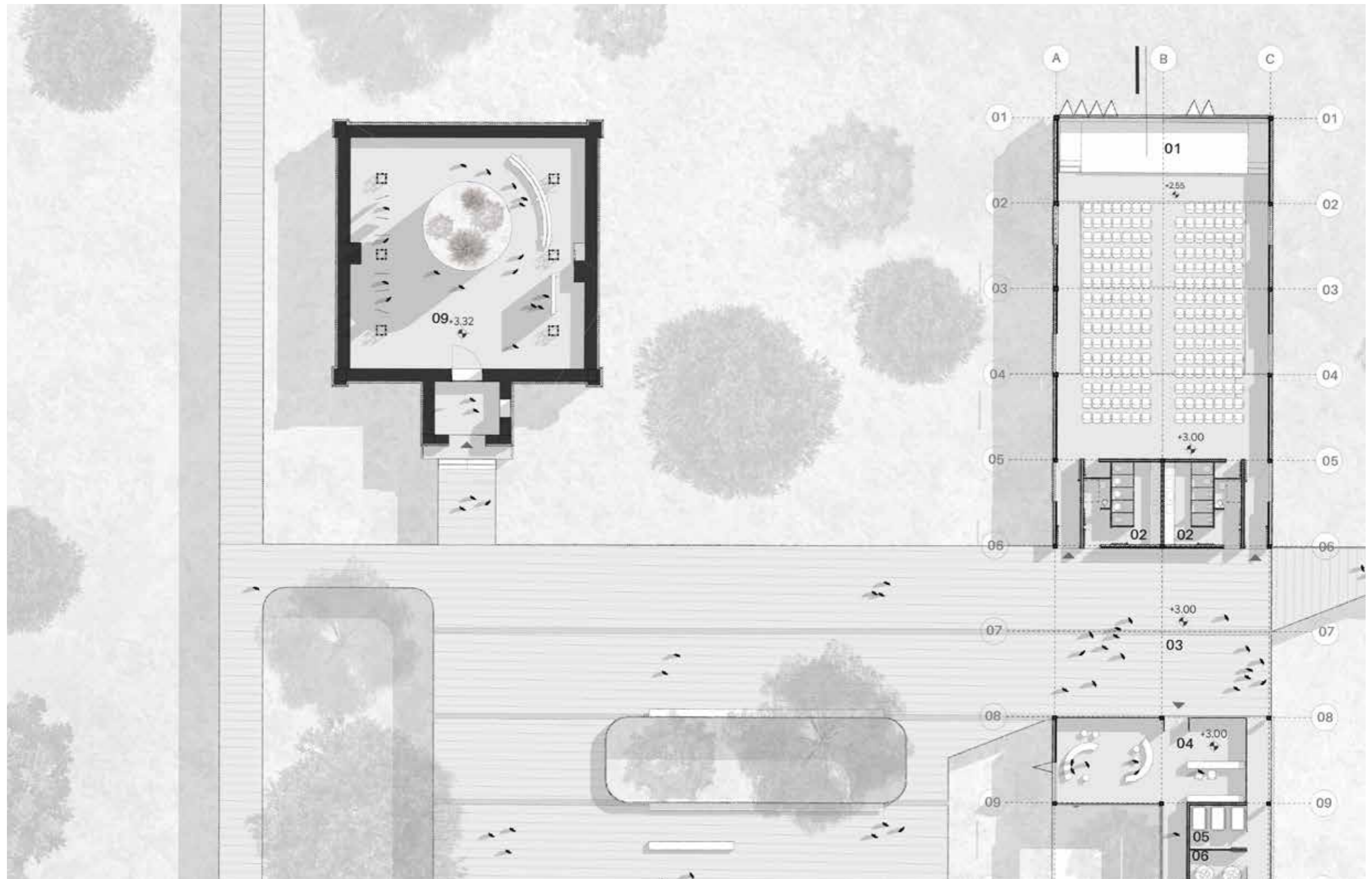

Memória

*Casa da Guarda:
exposição temporária
loja
mirante*

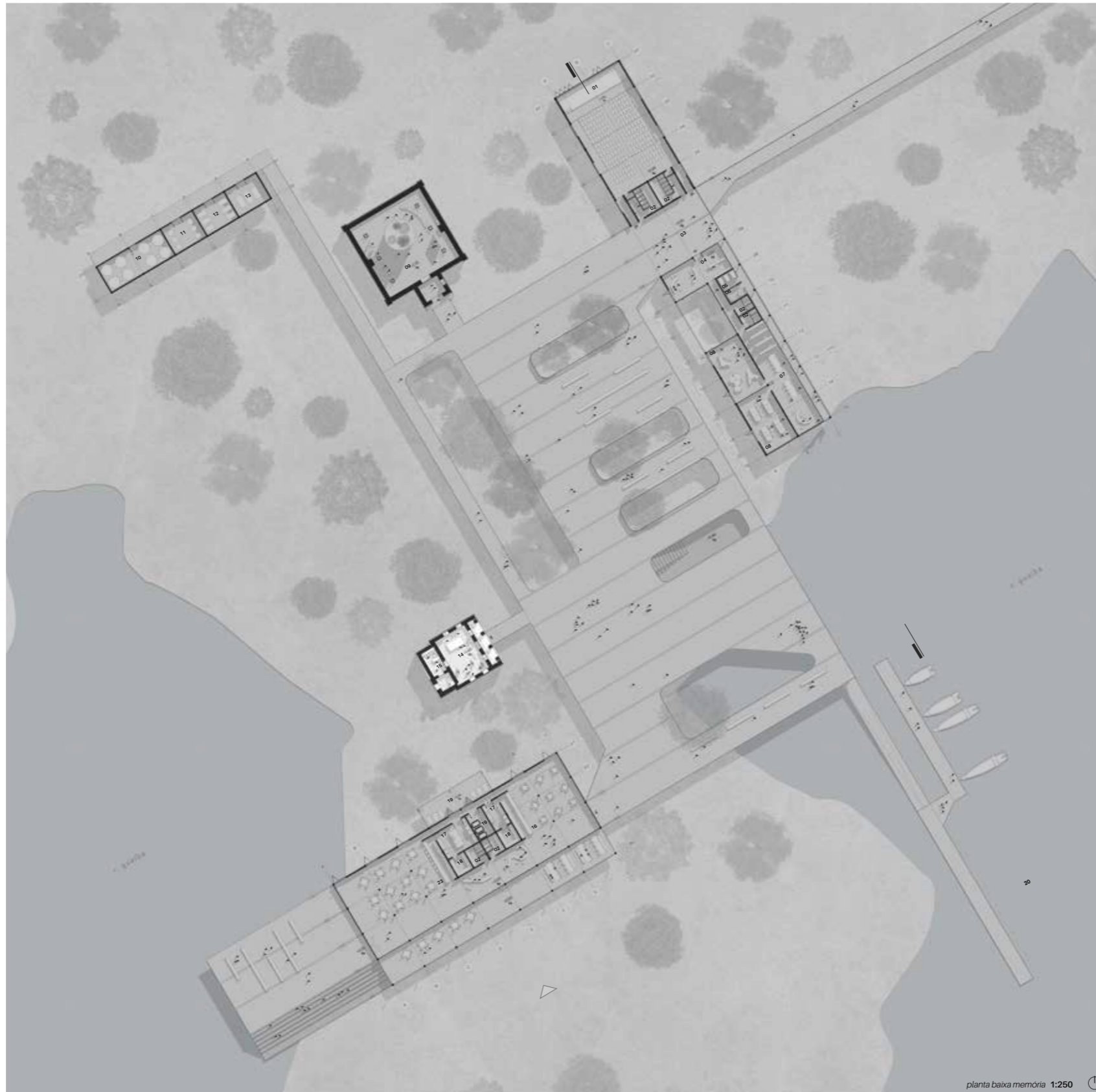

Memória

Casa da Guarda:
exposição temporária
loja
mirante



Memória

Casa da Guarda:
exposição temporária



Memória

Casa da Guarda:
loja



Memória

Casa da Guarda:
mirante



Memória

café
restaurante
mirante Orla

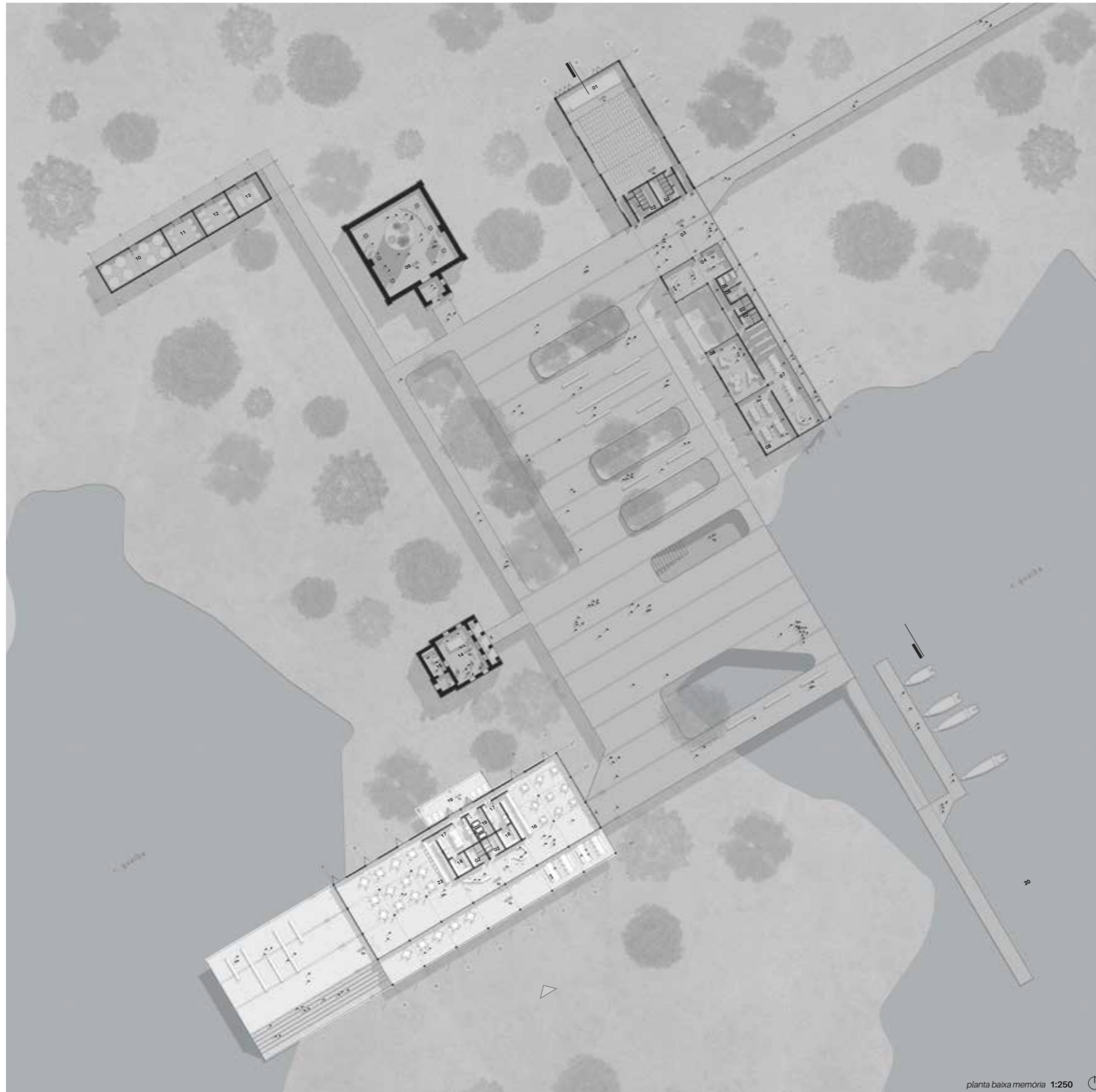

Memória

café
restaurante
mirante Orla

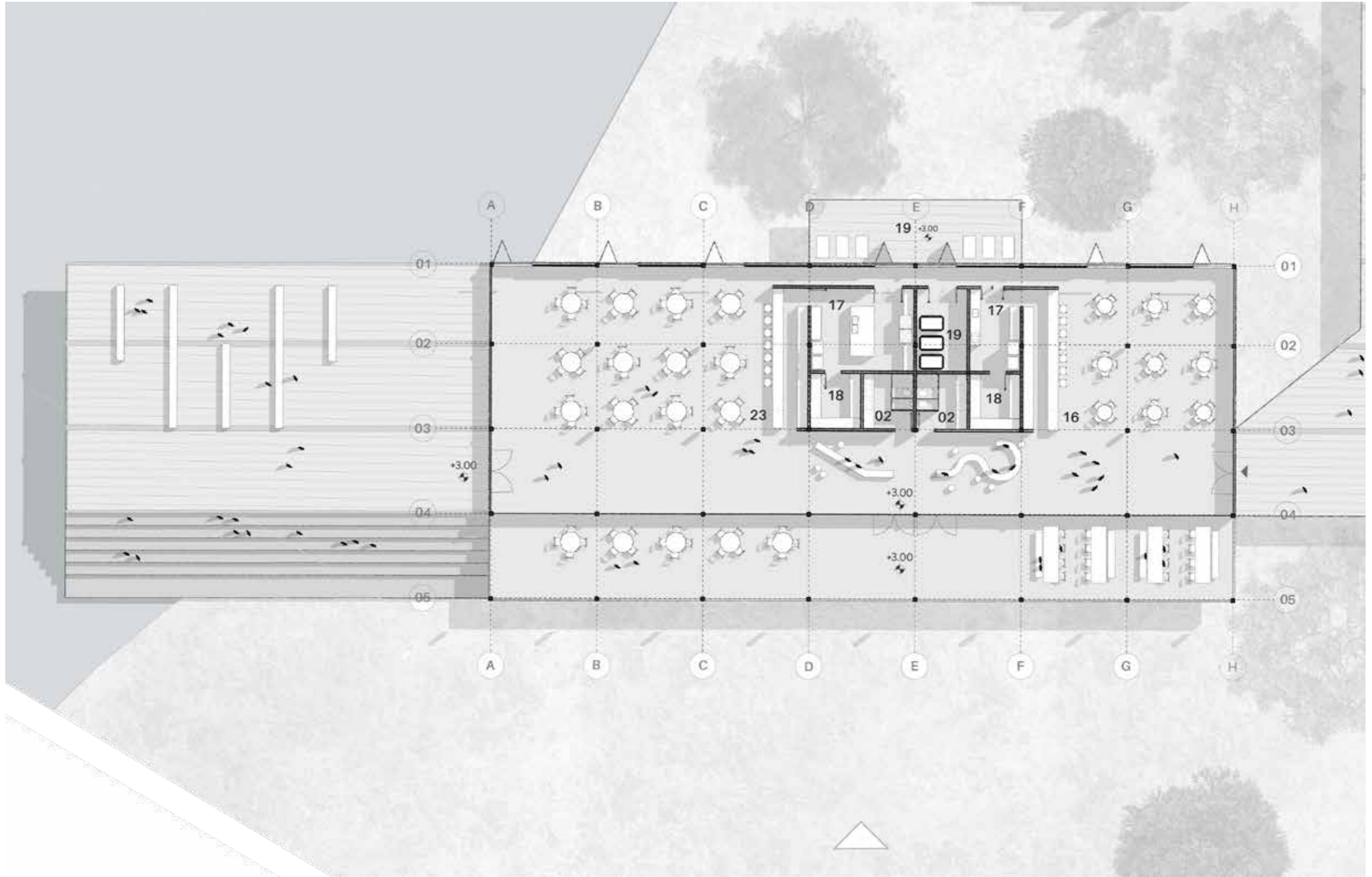

Memória

café

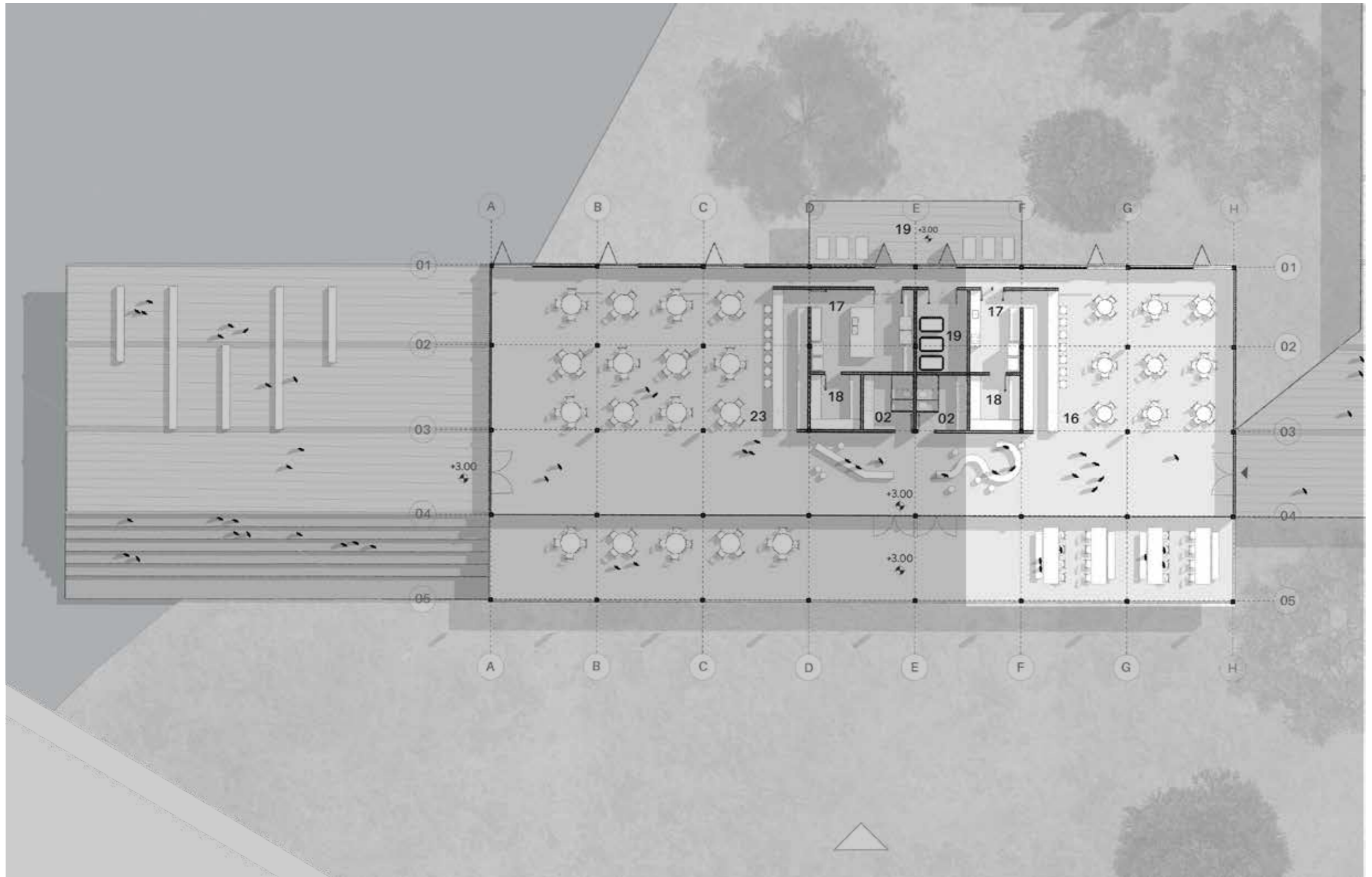

Memória

área técnica
pátio de serviço

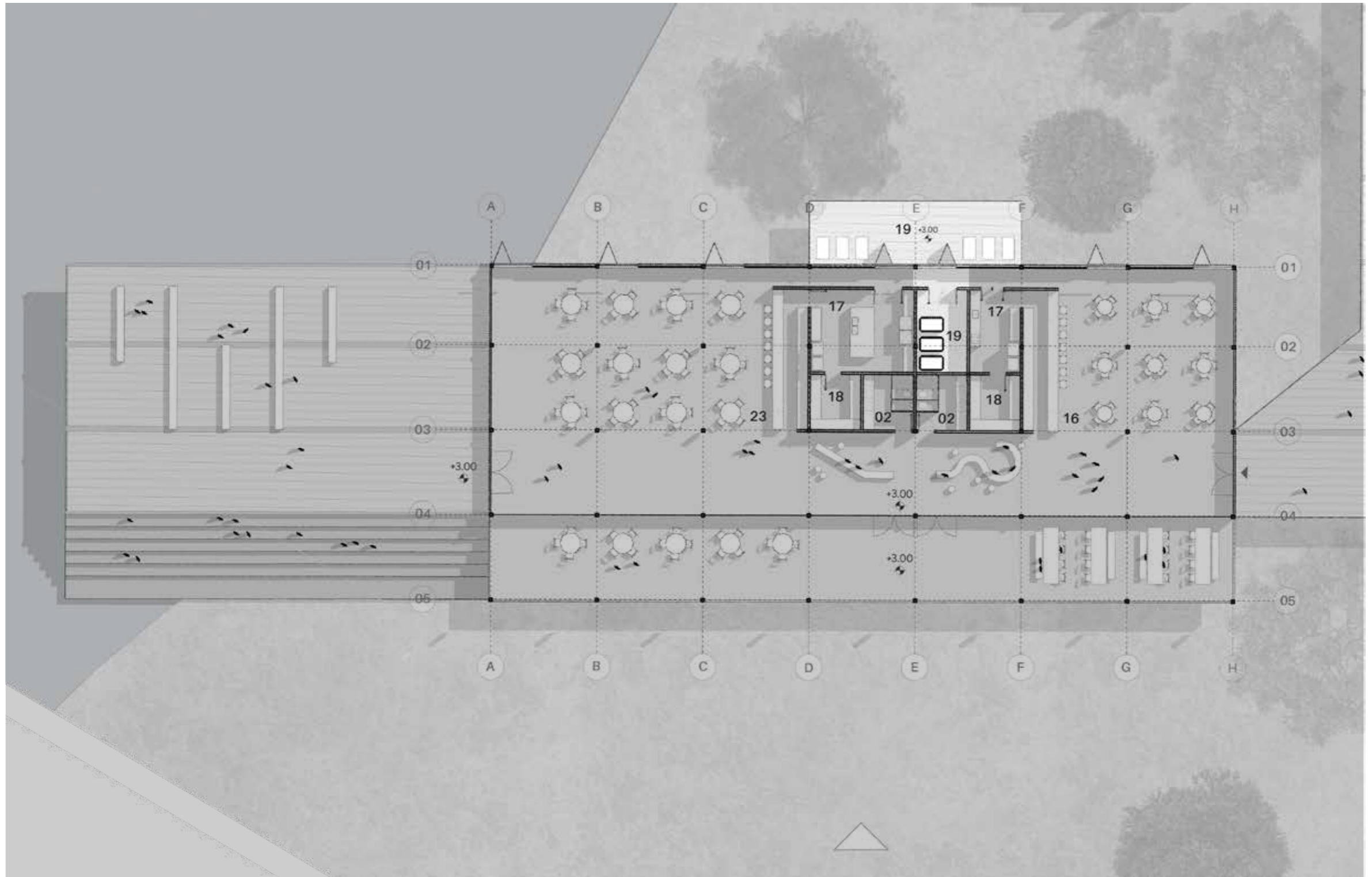

Memória

restaurante

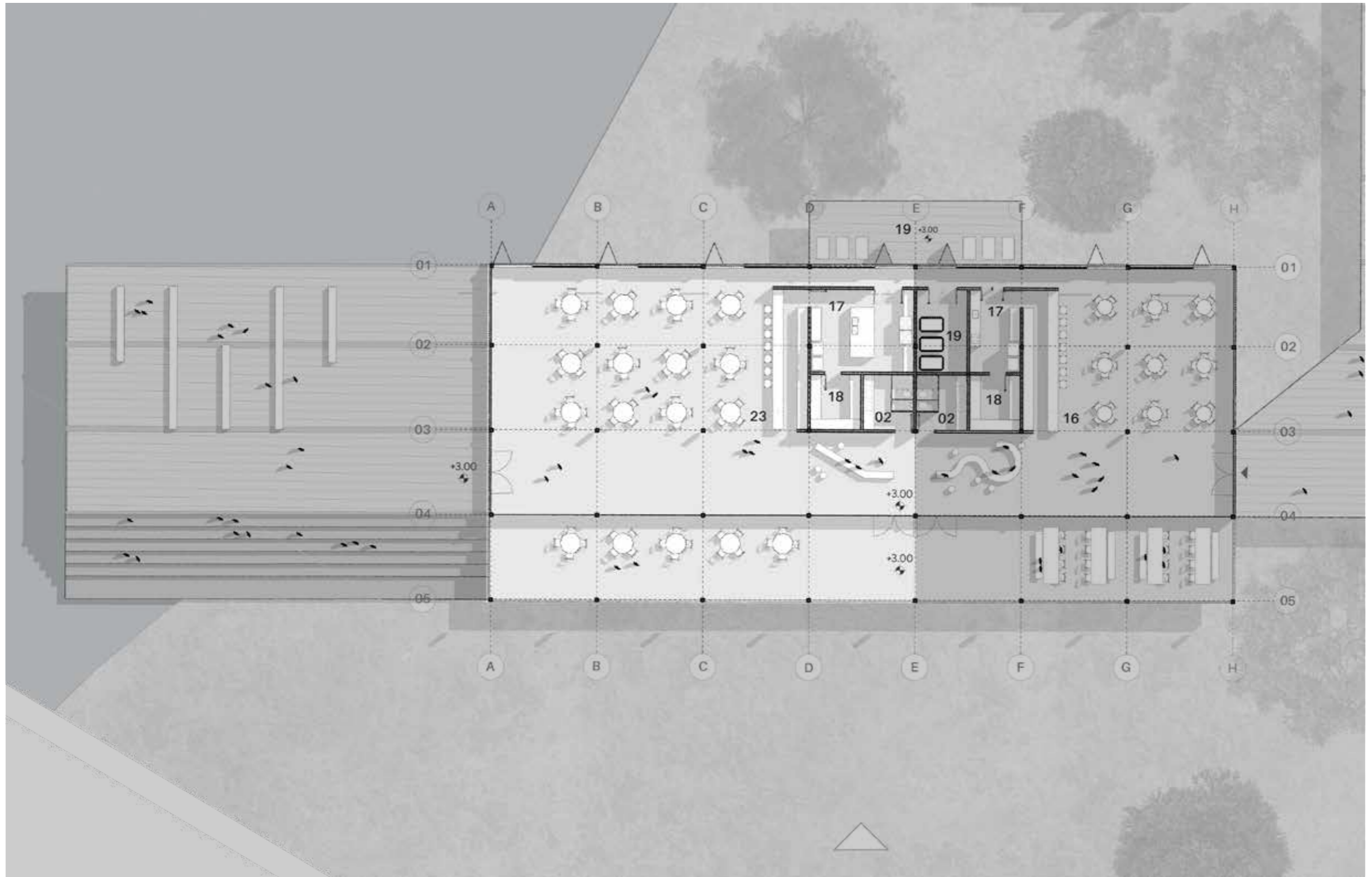

Memória

mirante Orla

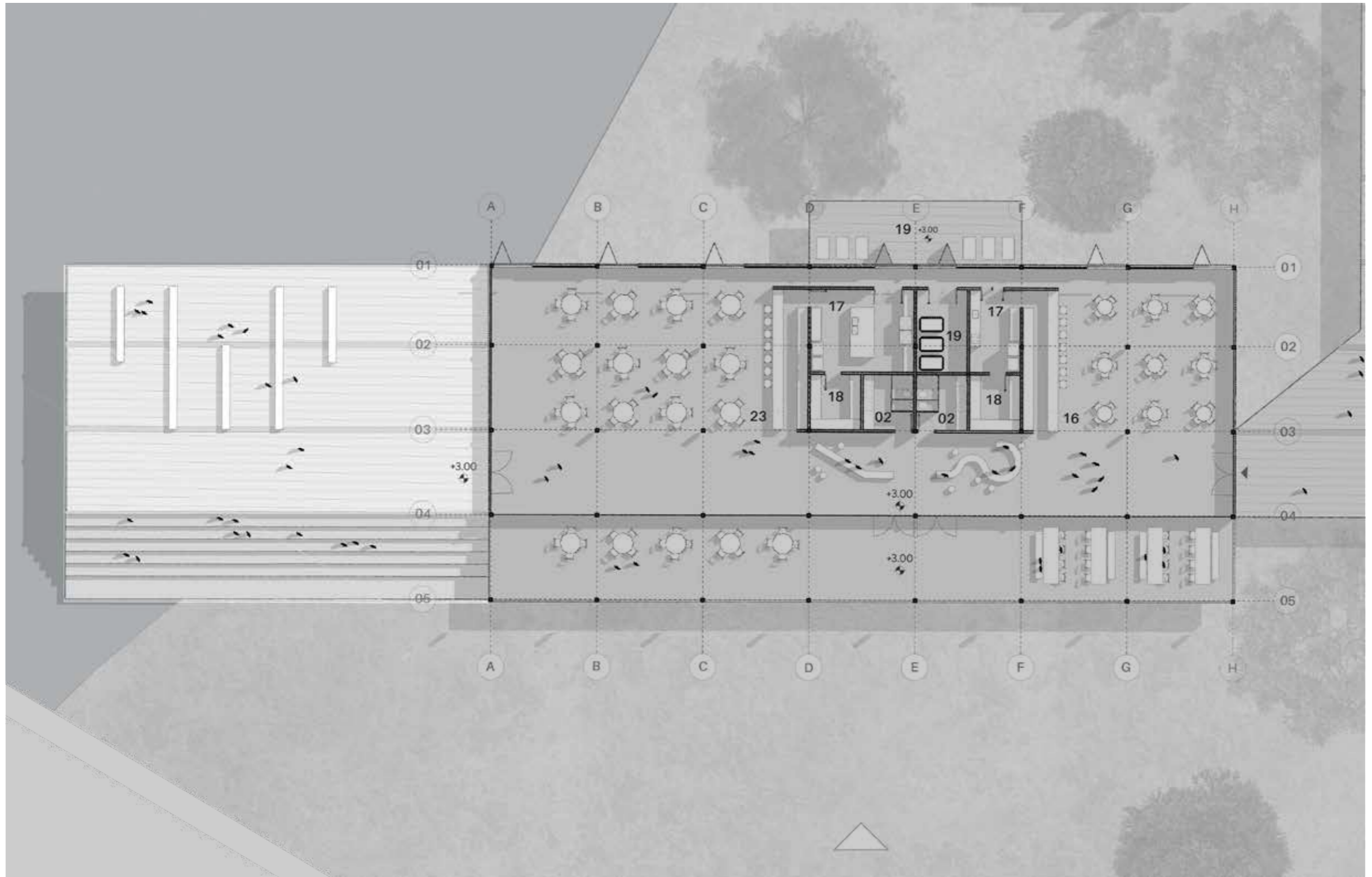

Memória

café
restaurante
mirante Orla

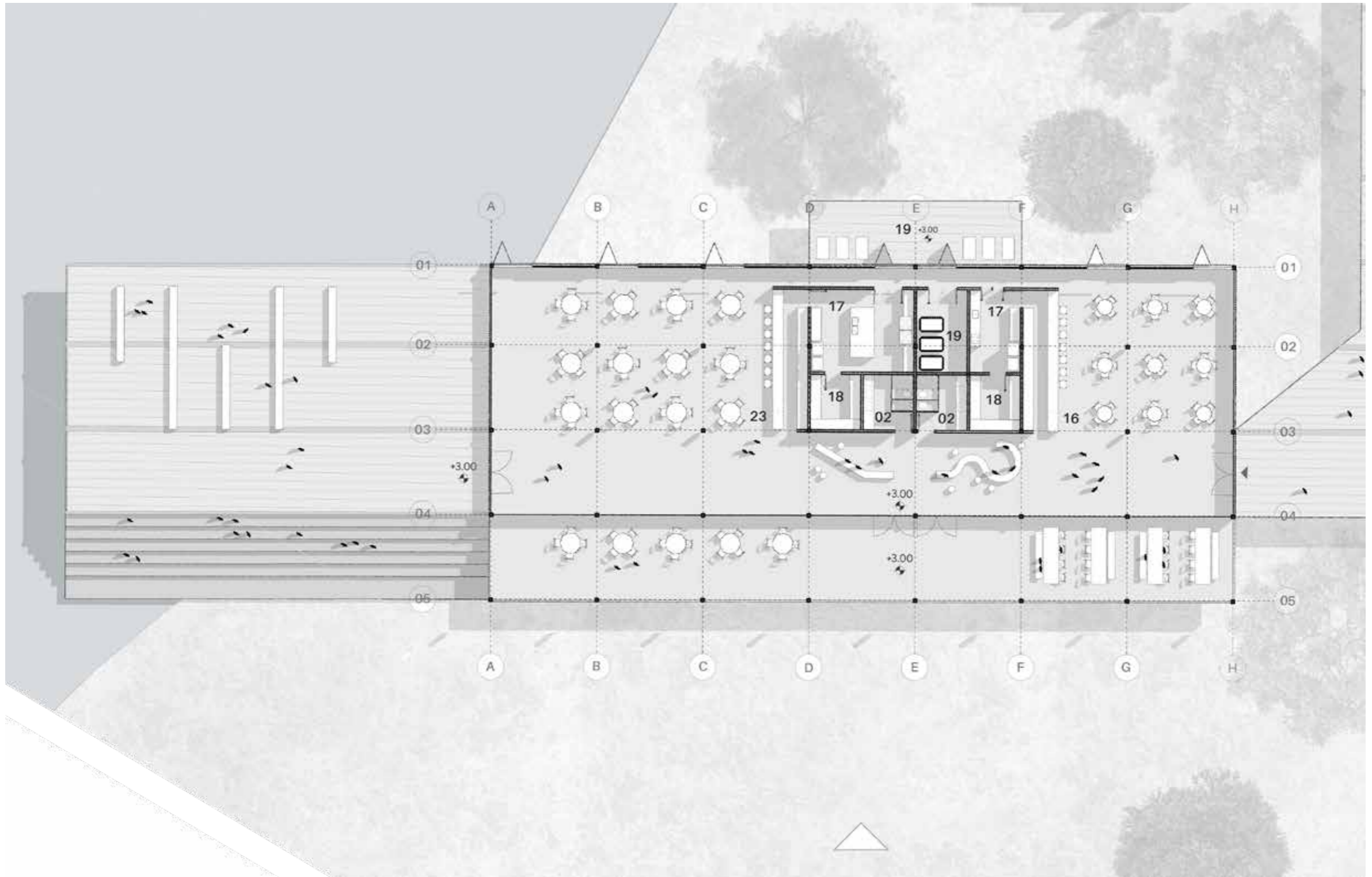

Memória
planta baixa

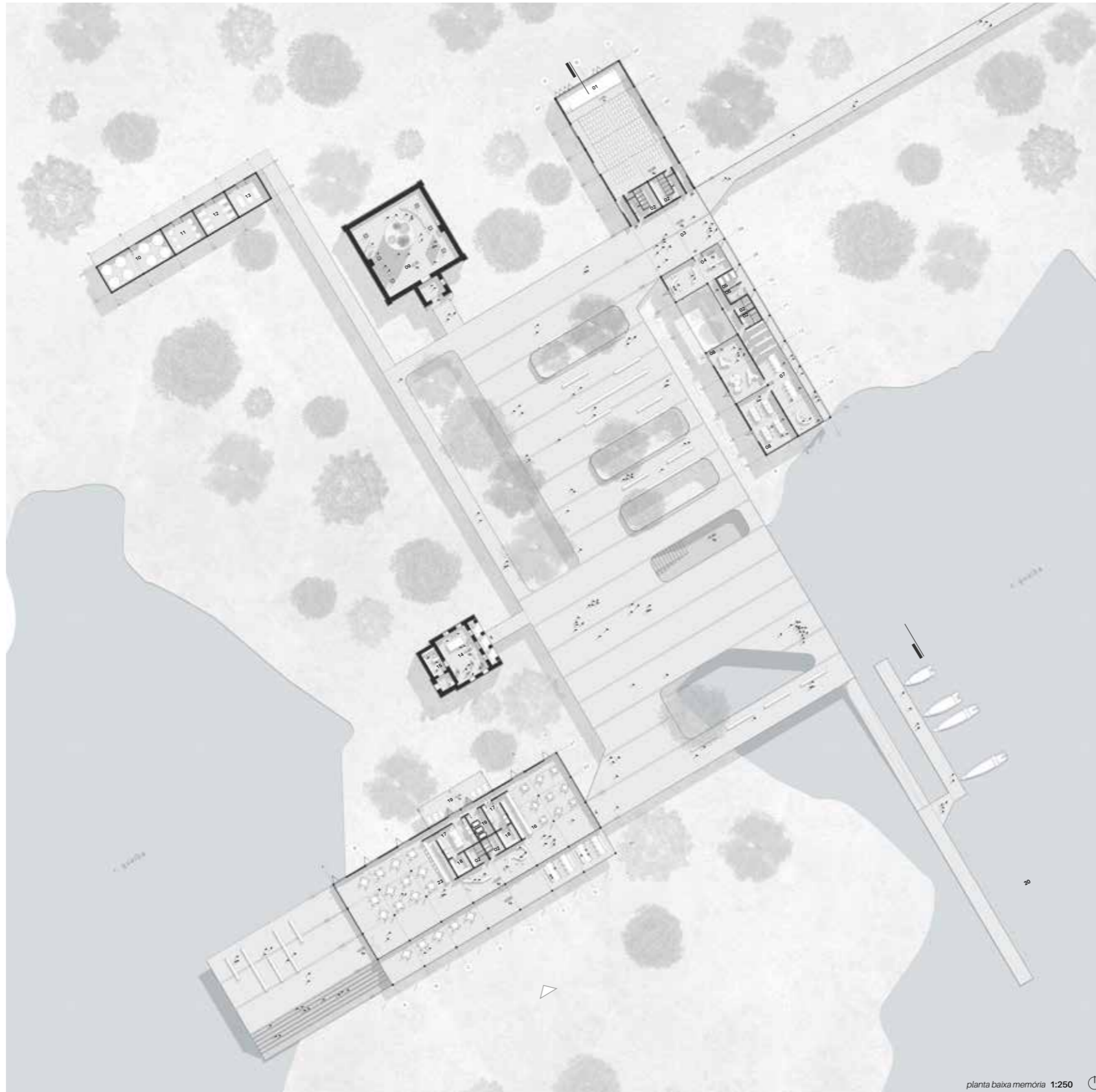

planta baixa memória 1:250

Memória

Fachada sul

Corte longitudinal edifício recepção + auditório



Memória



Memória



Memória



Memória



Memória



Memória



Conhecimento

Partido Geral
Centro conhecimento

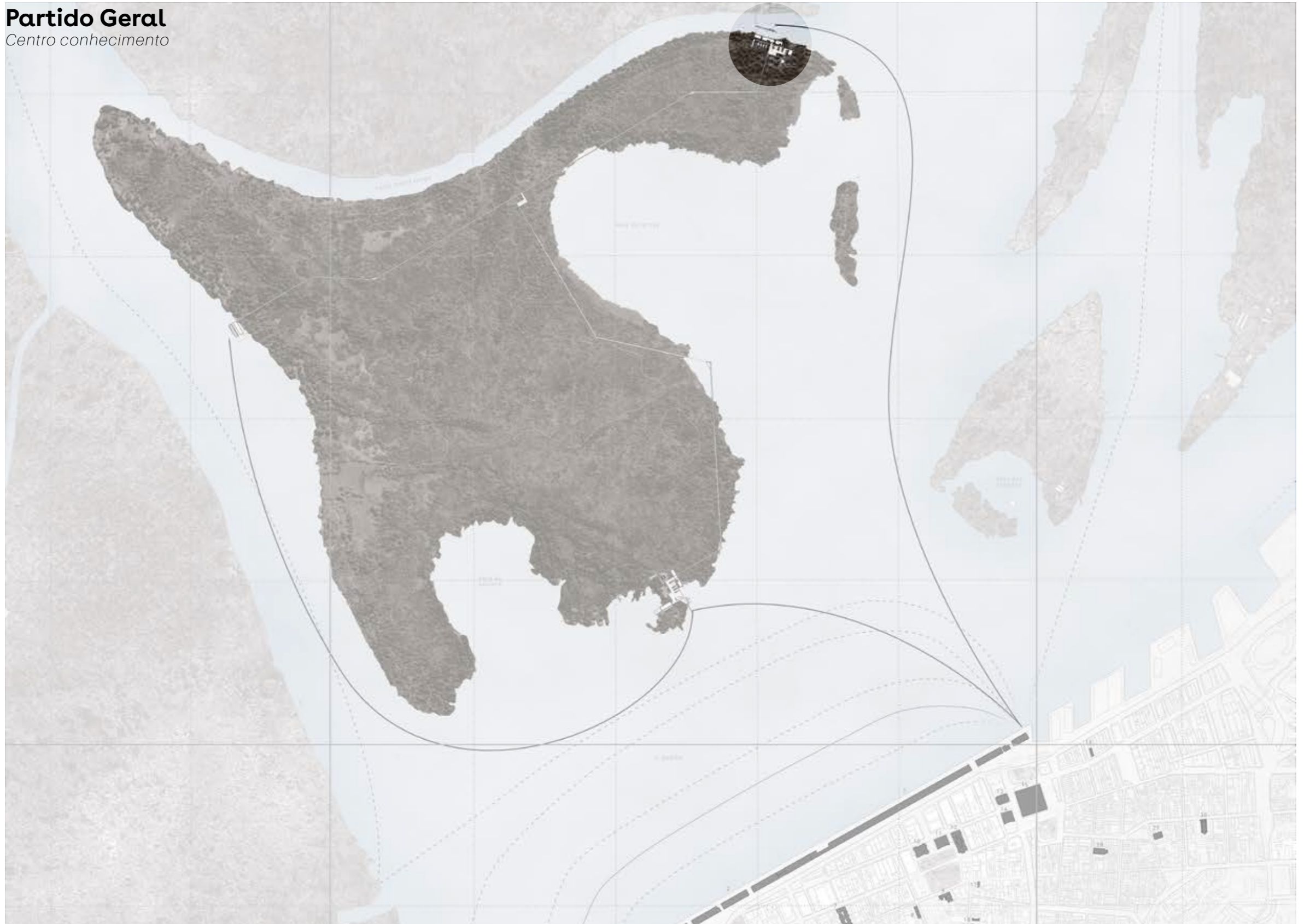

Conhecimento

edificação existente



Conhecimento

posicionamento programa

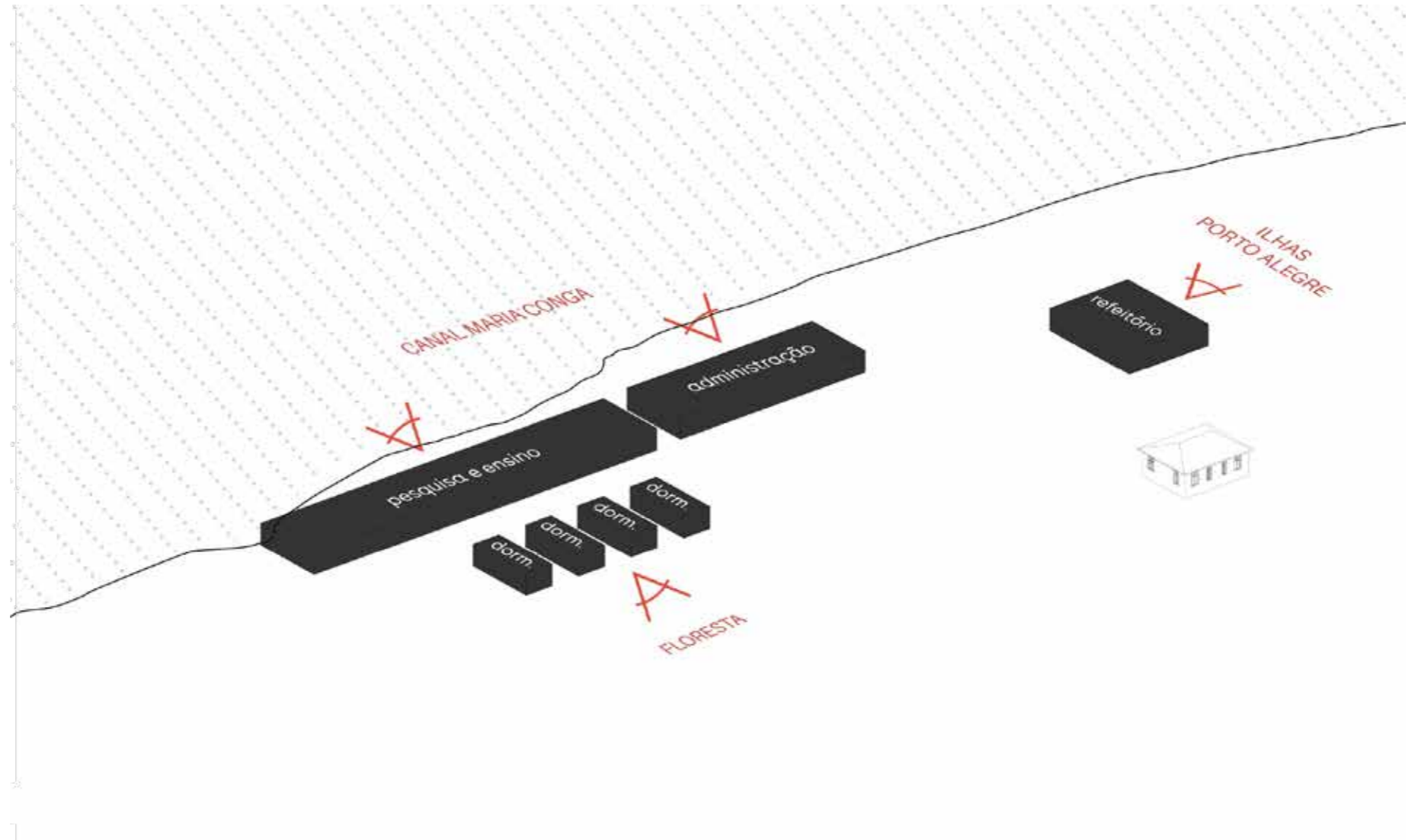

Conhecimento

praça que organiza

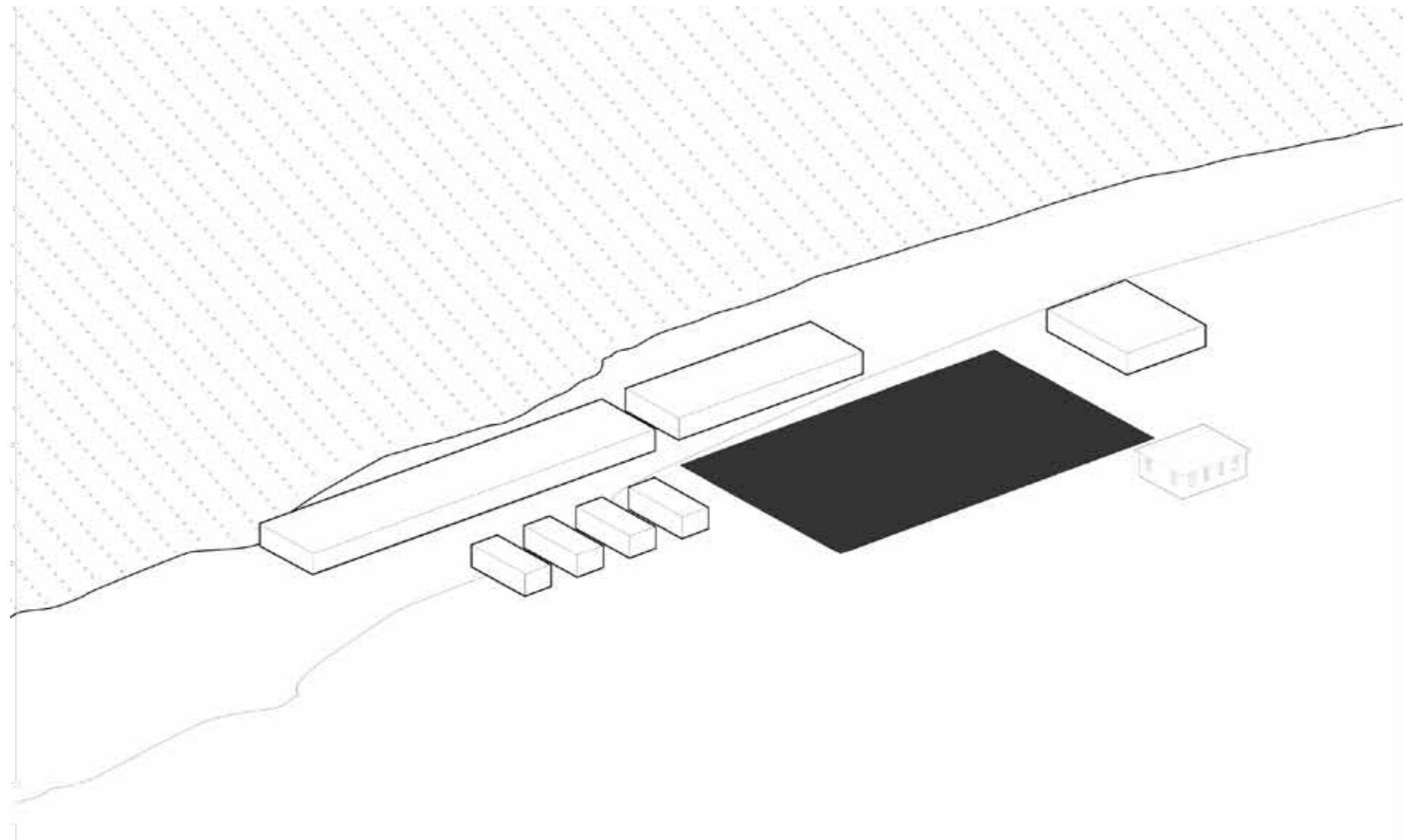

Conhecimento

subtrações

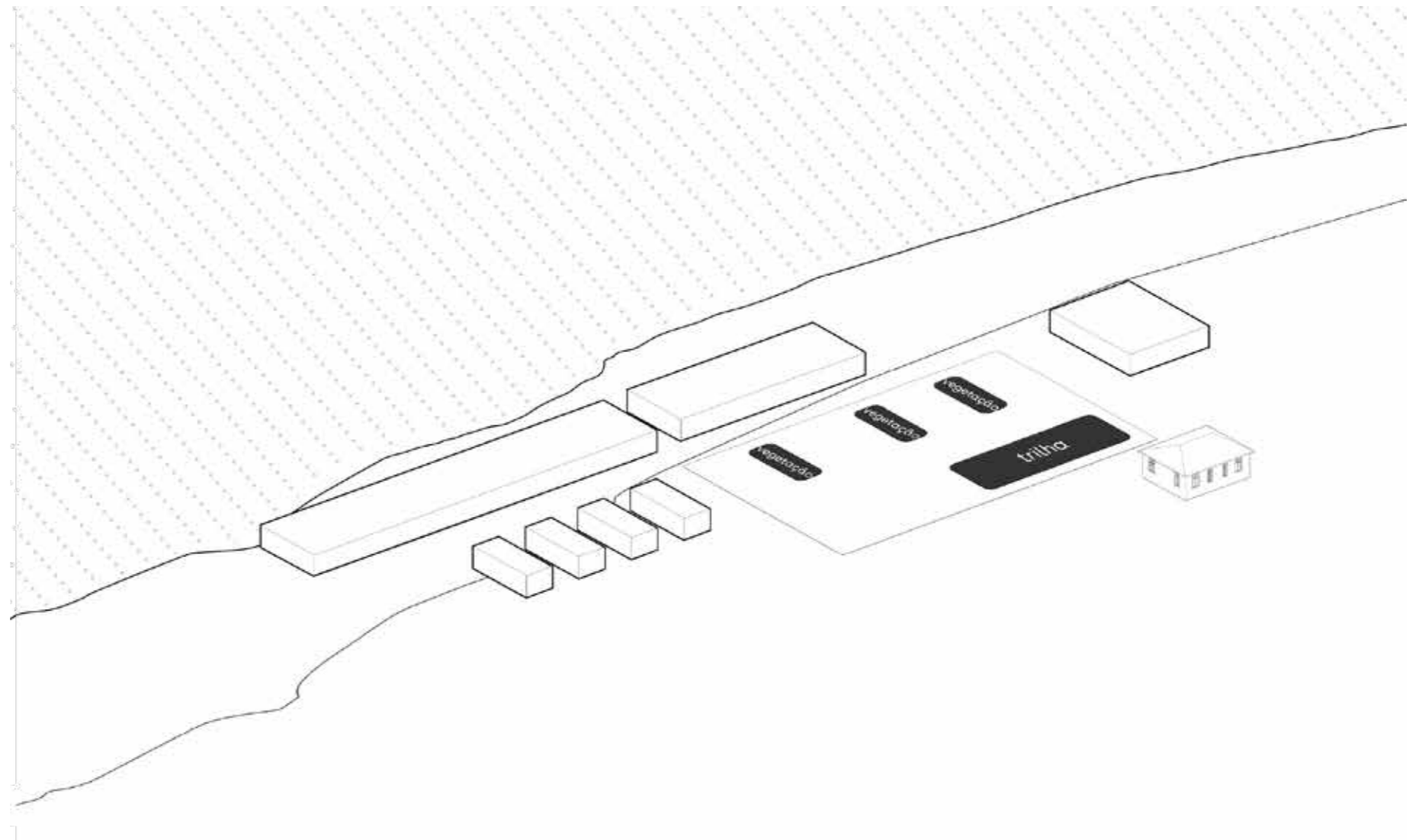

Conhecimento

implantação

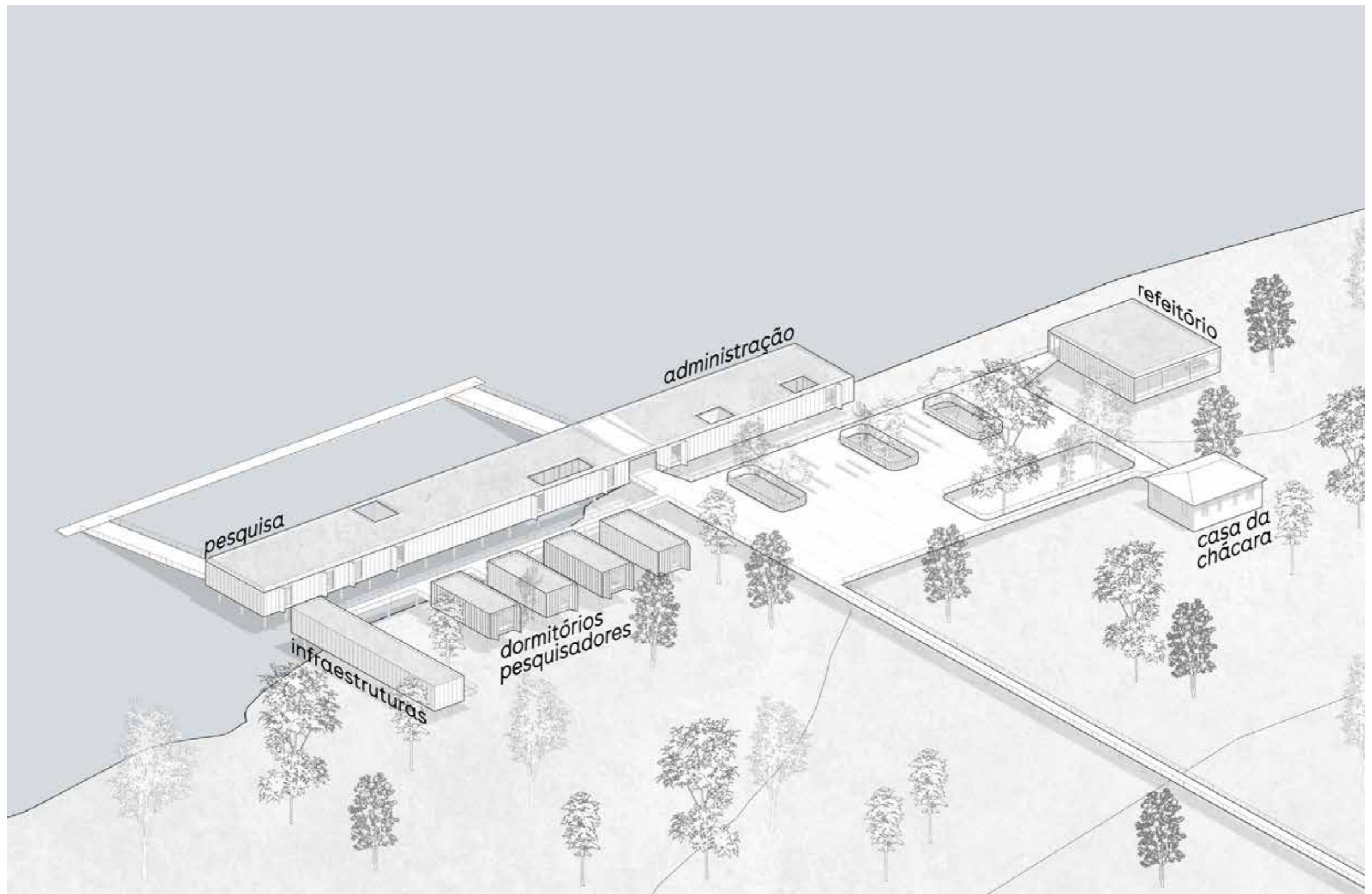

Conhecimento

planta baixa



Conhecimento

pesquisa
administração



Conhecimento

pesquisa
administração



Conhecimento

recepção

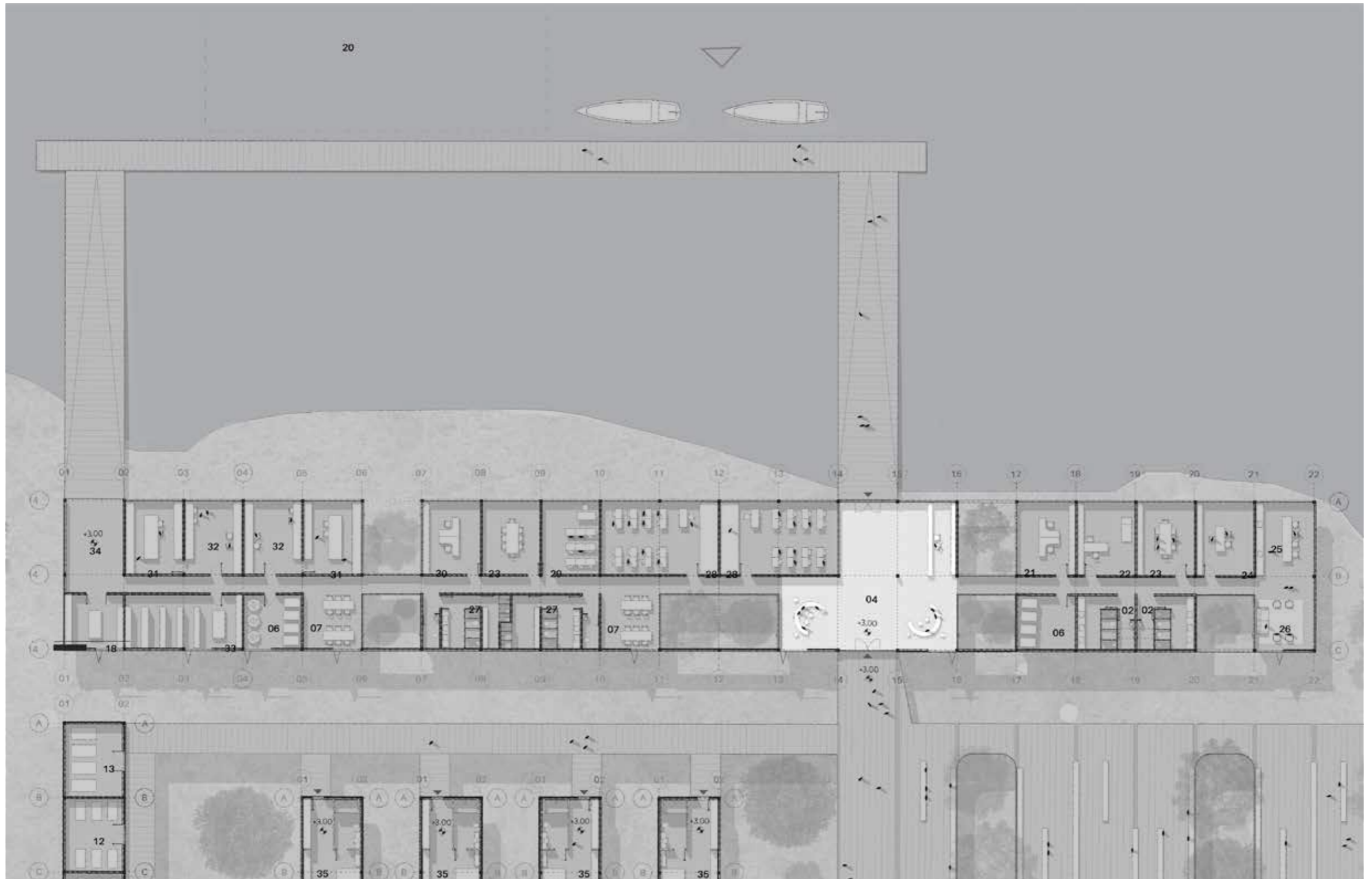

Conhecimento

secretaria

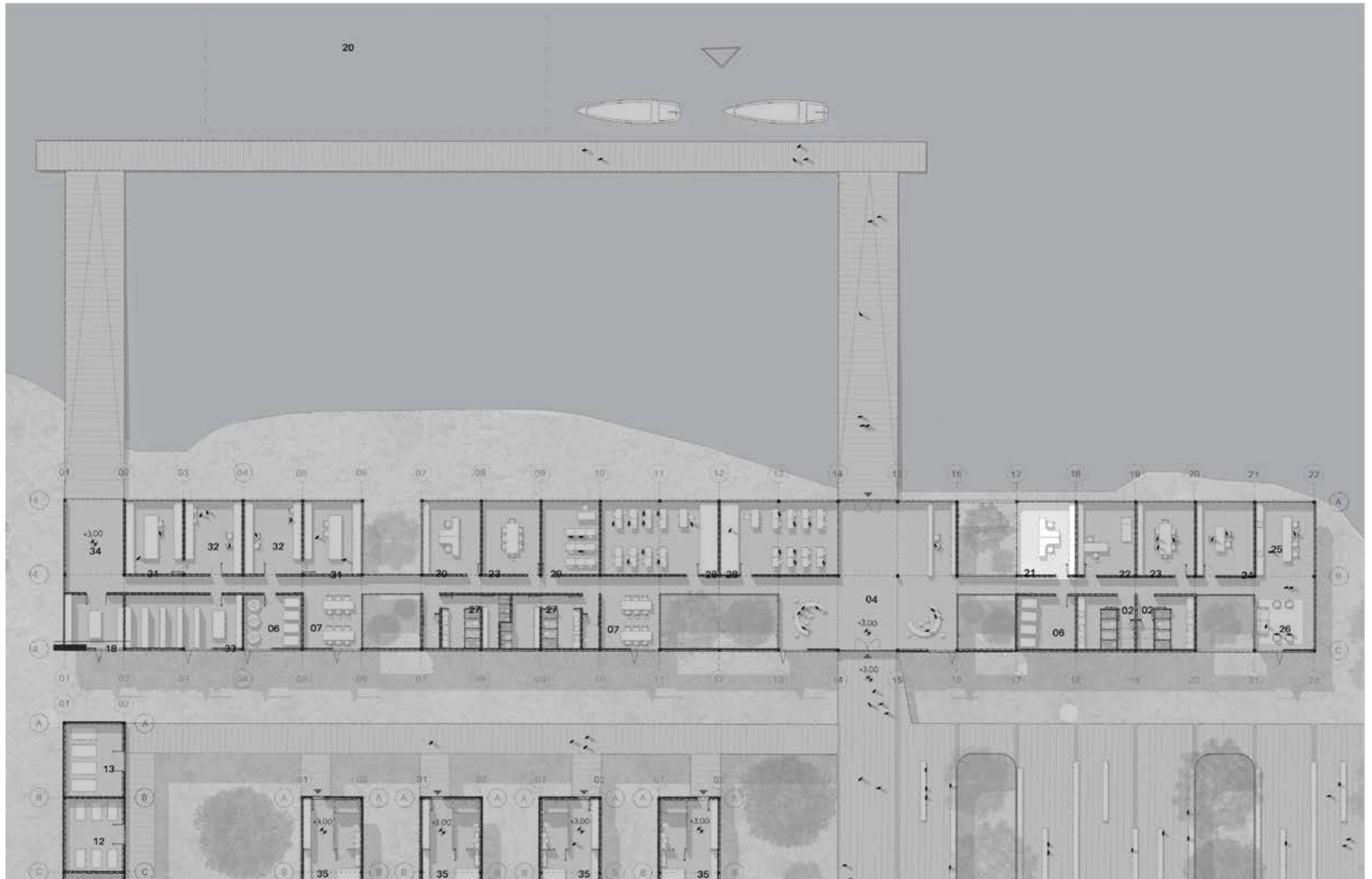

Conhecimento

enfermaria

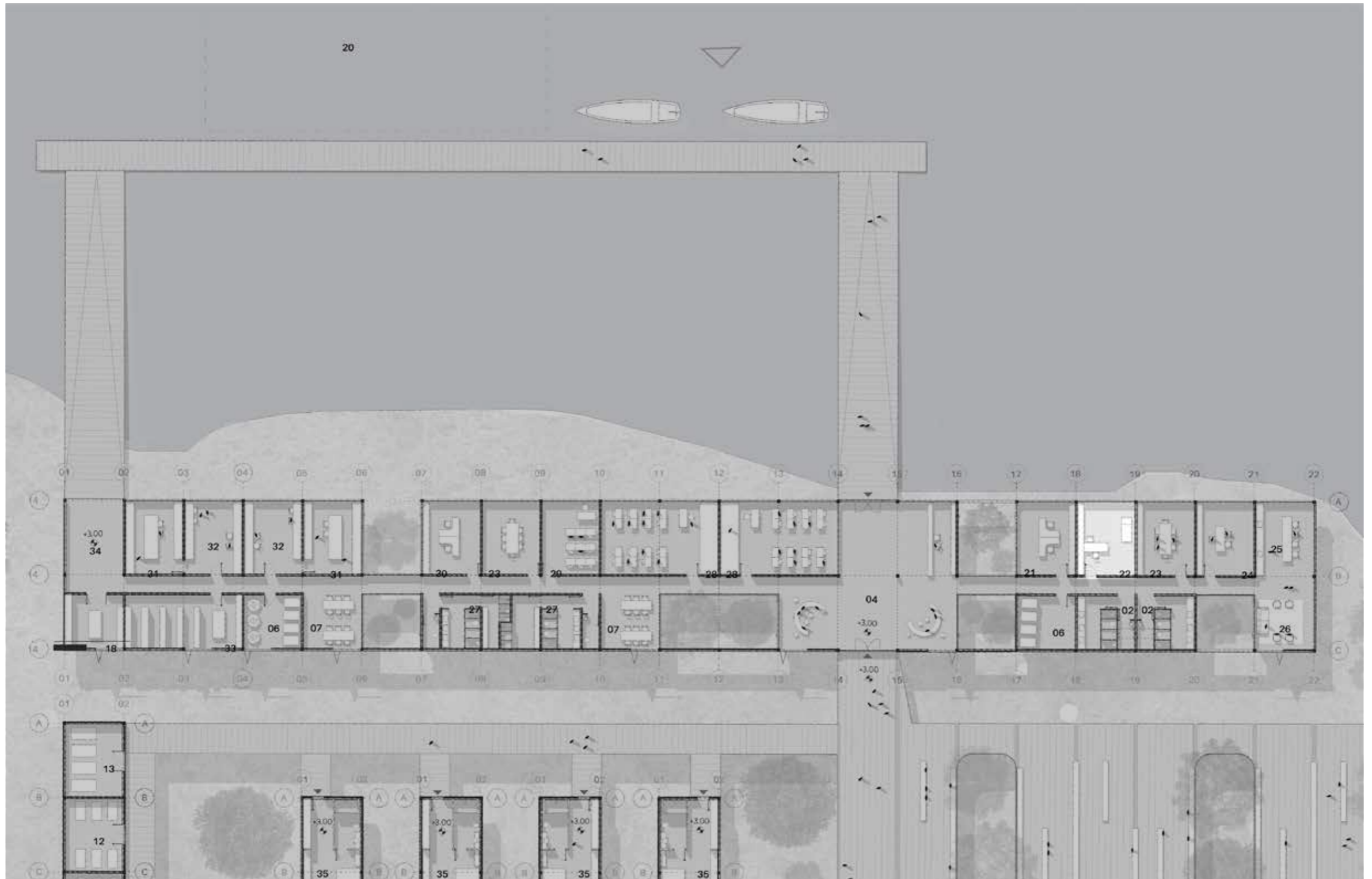

Conhecimento

sala de reuniões



Conhecimento

diretoria

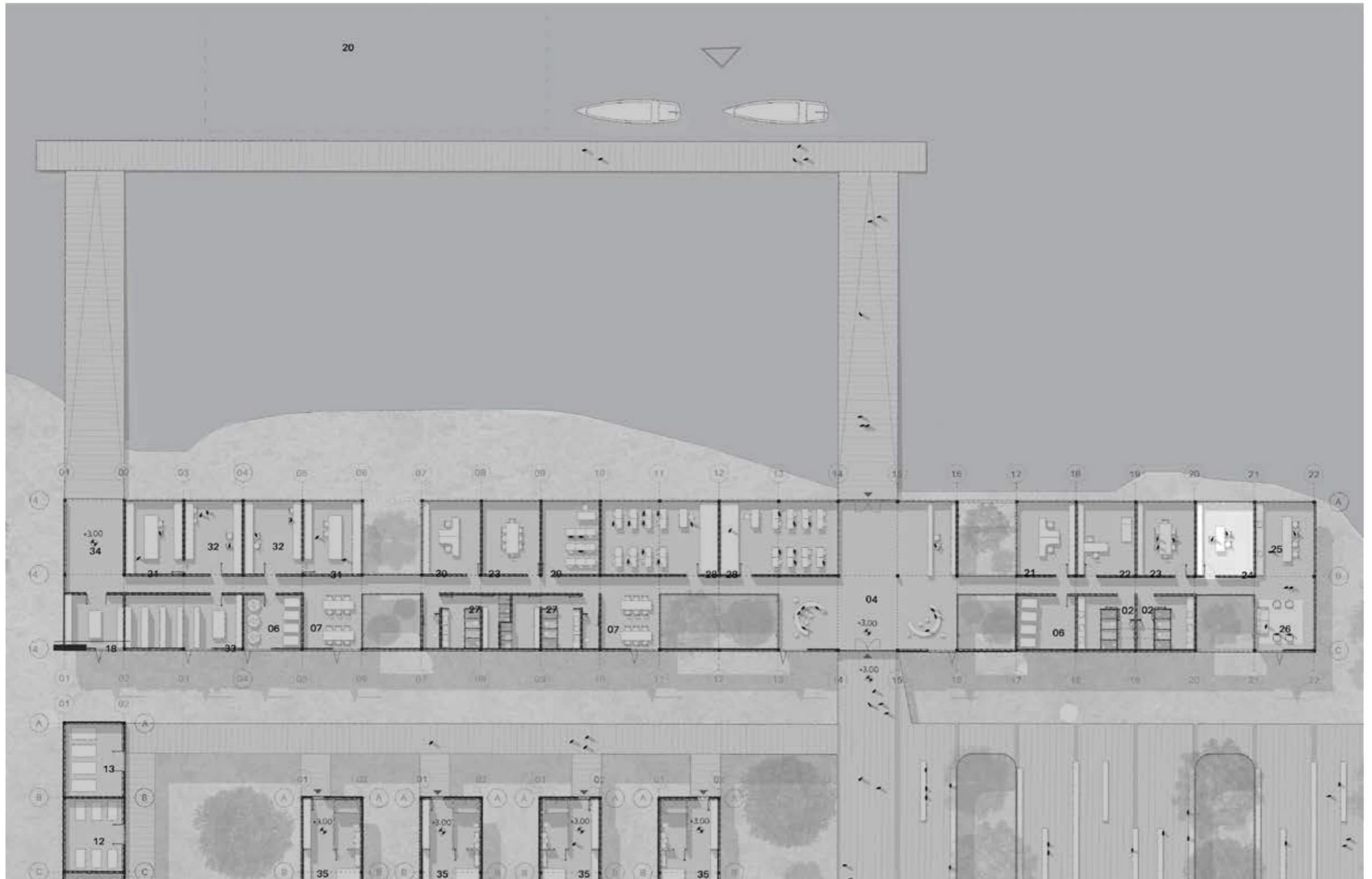

Conhecimento

copa e estar funcionários



Conhecimento

área técnica

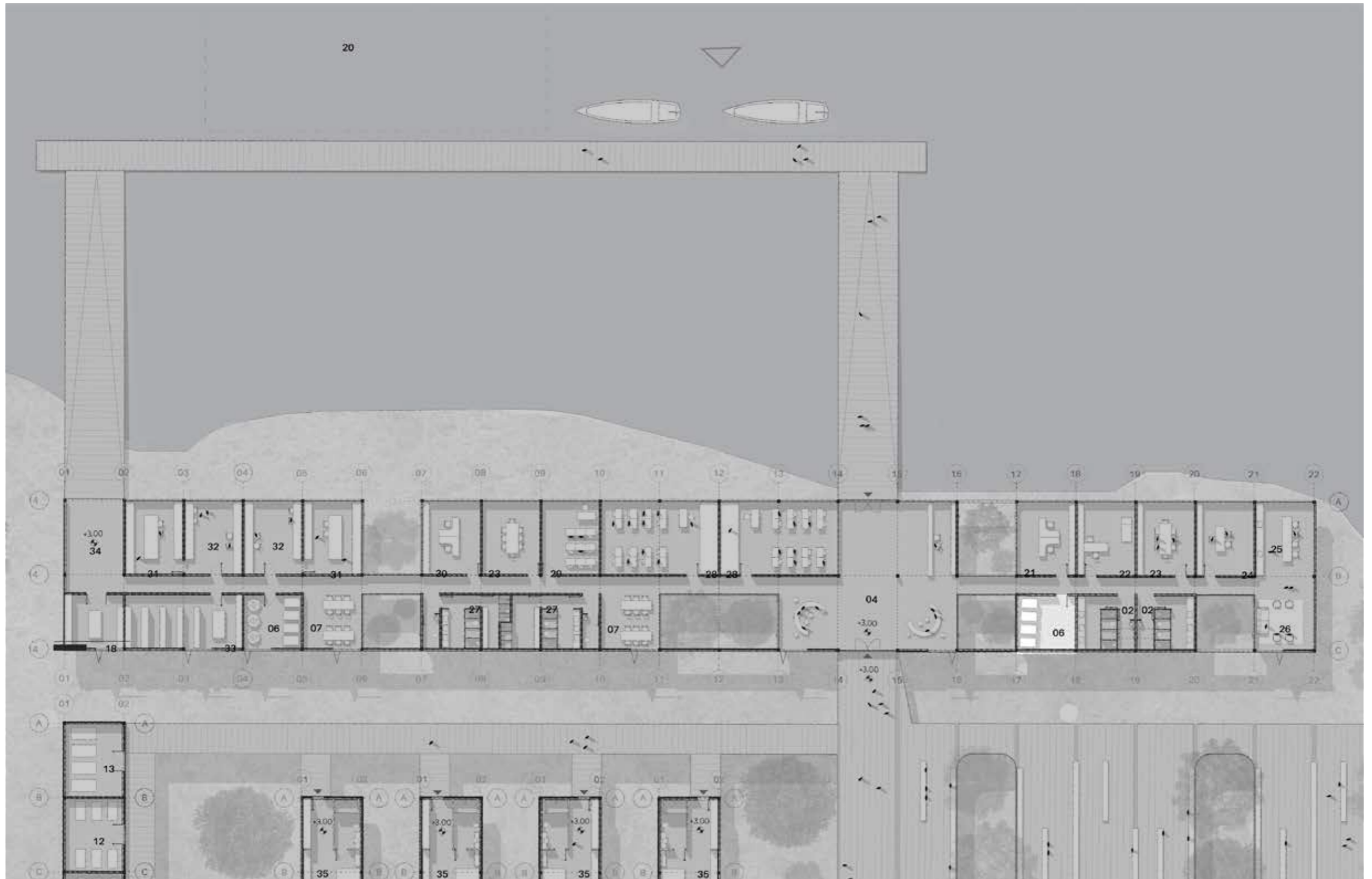

Conhecimento

salas de aula

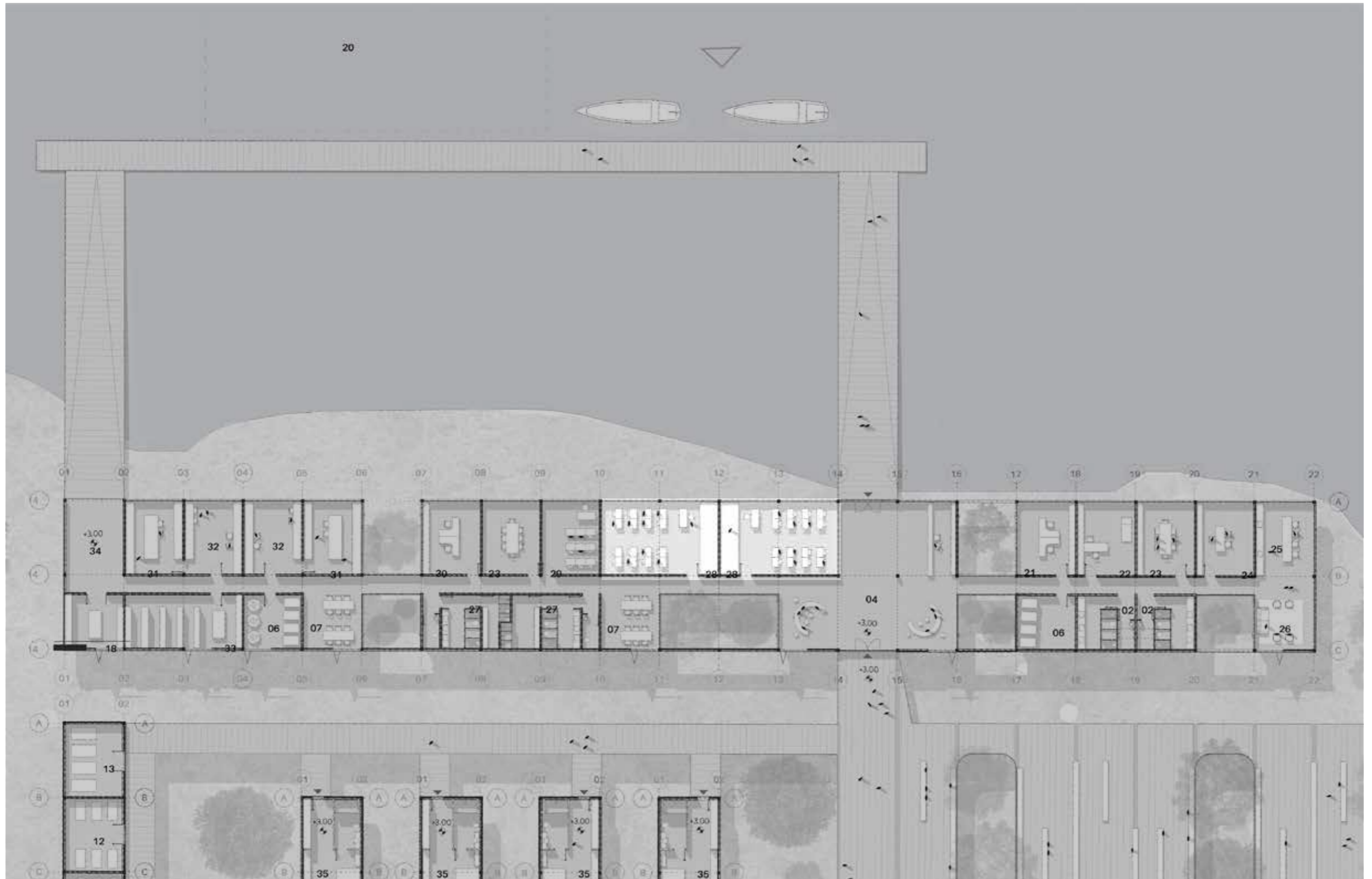

Conhecimento

área de estudos



Conhecimento

videoteca

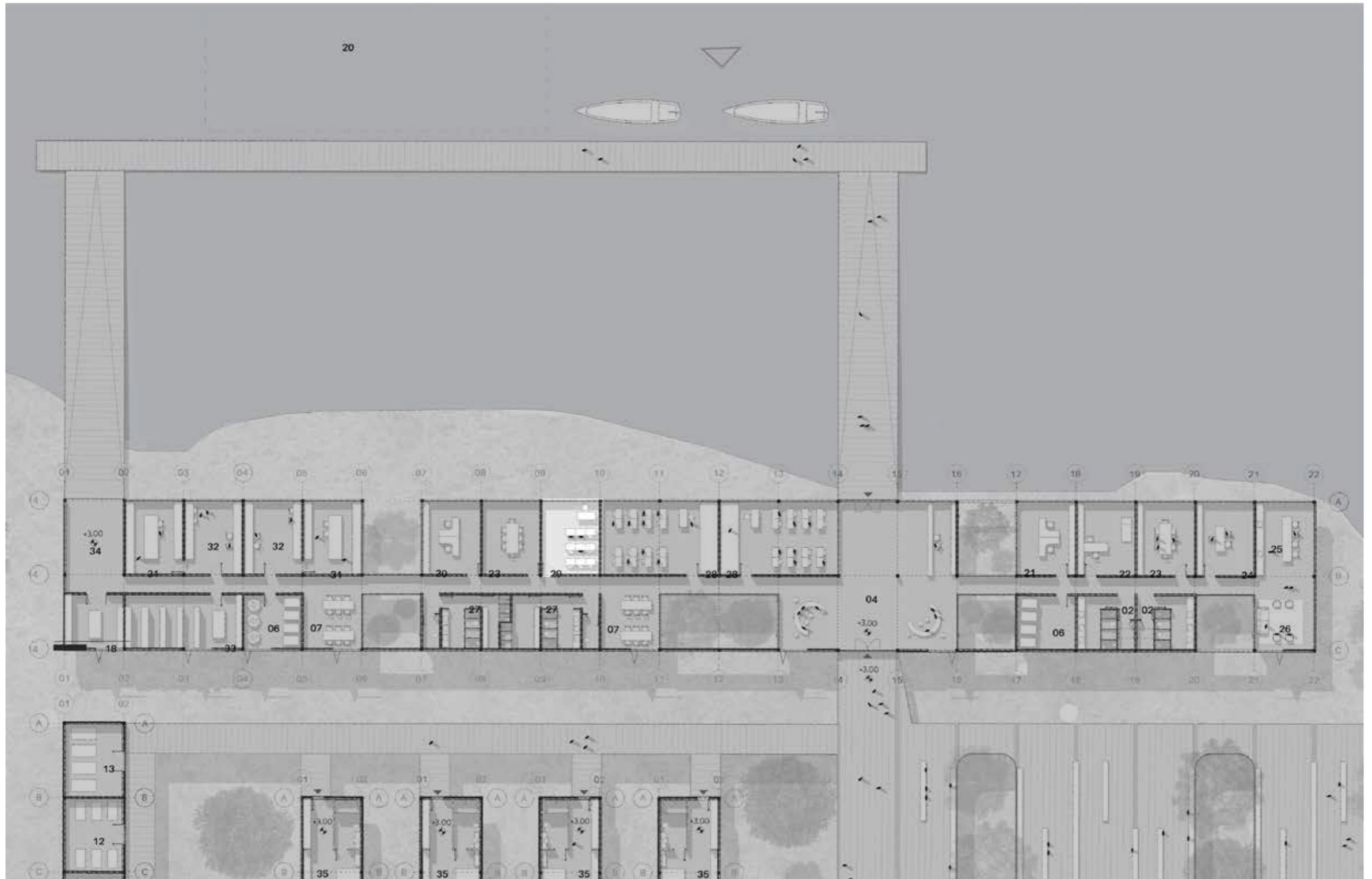

Conhecimento

sanitários e vestiário funcionários

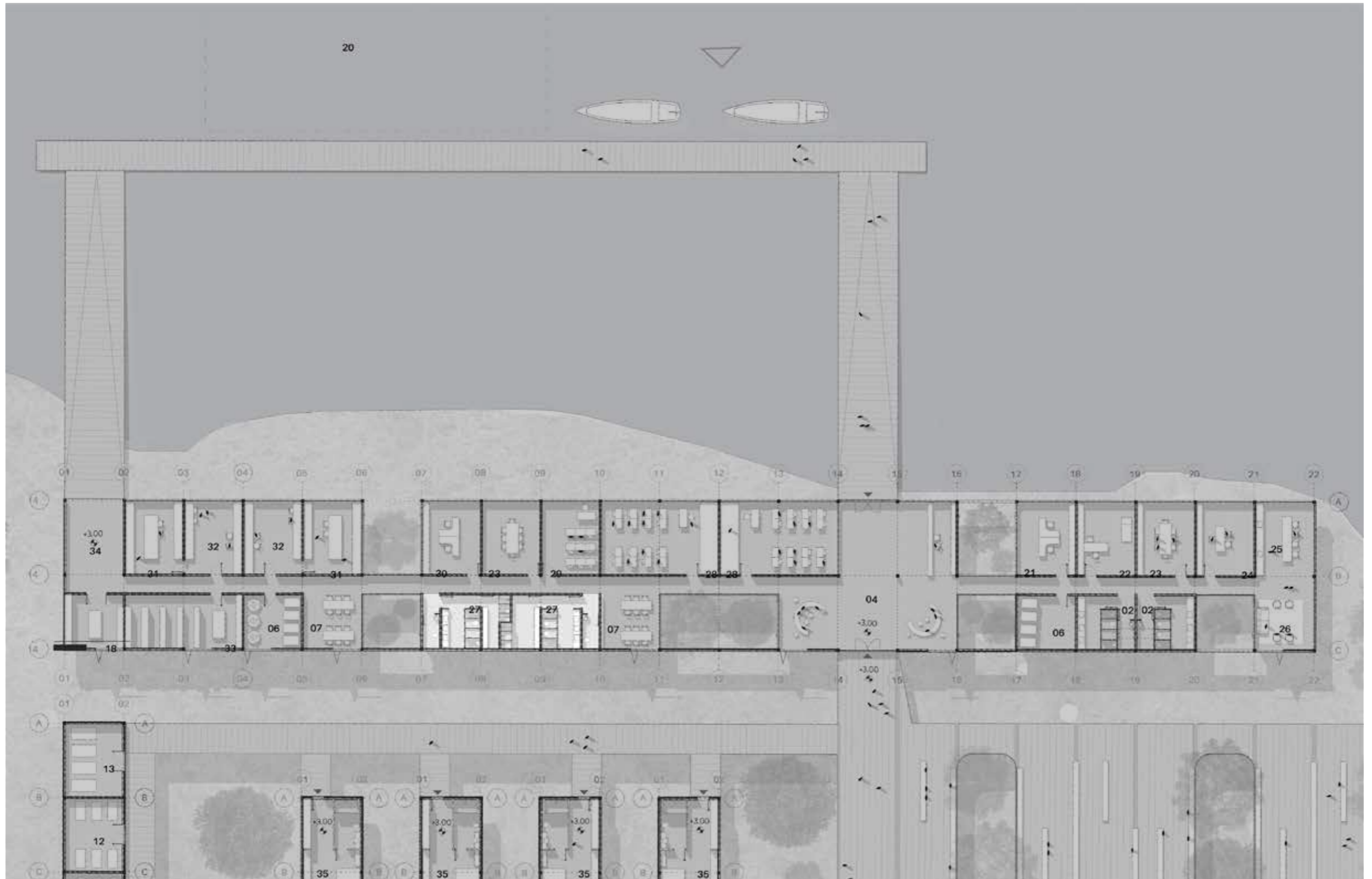

Conhecimento

sala de reuniões



Conhecimento

sala de vigilância da SEMA

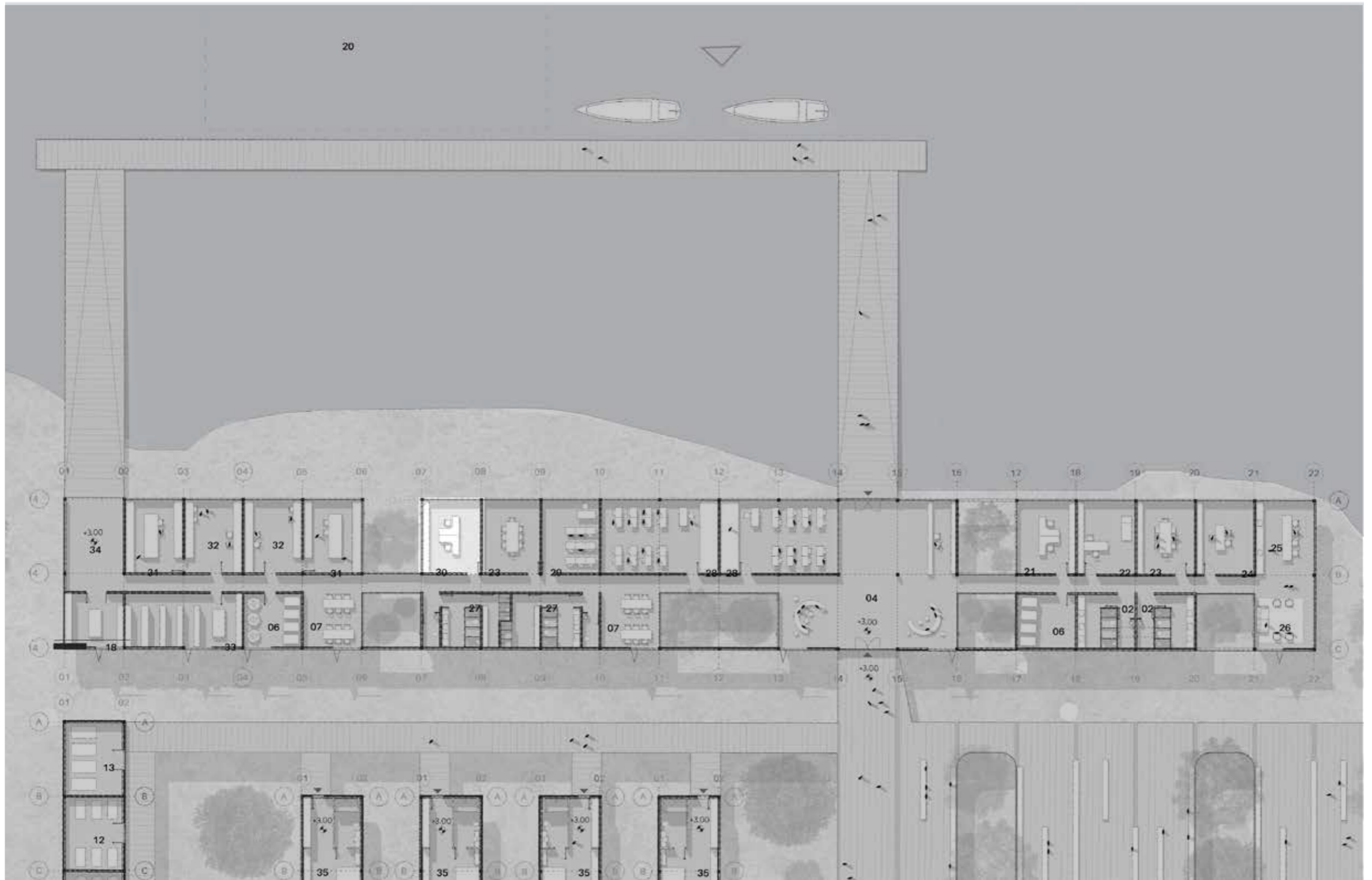

Conhecimento

laboratórios



Conhecimento

área de estudos



Conhecimento

área técnica

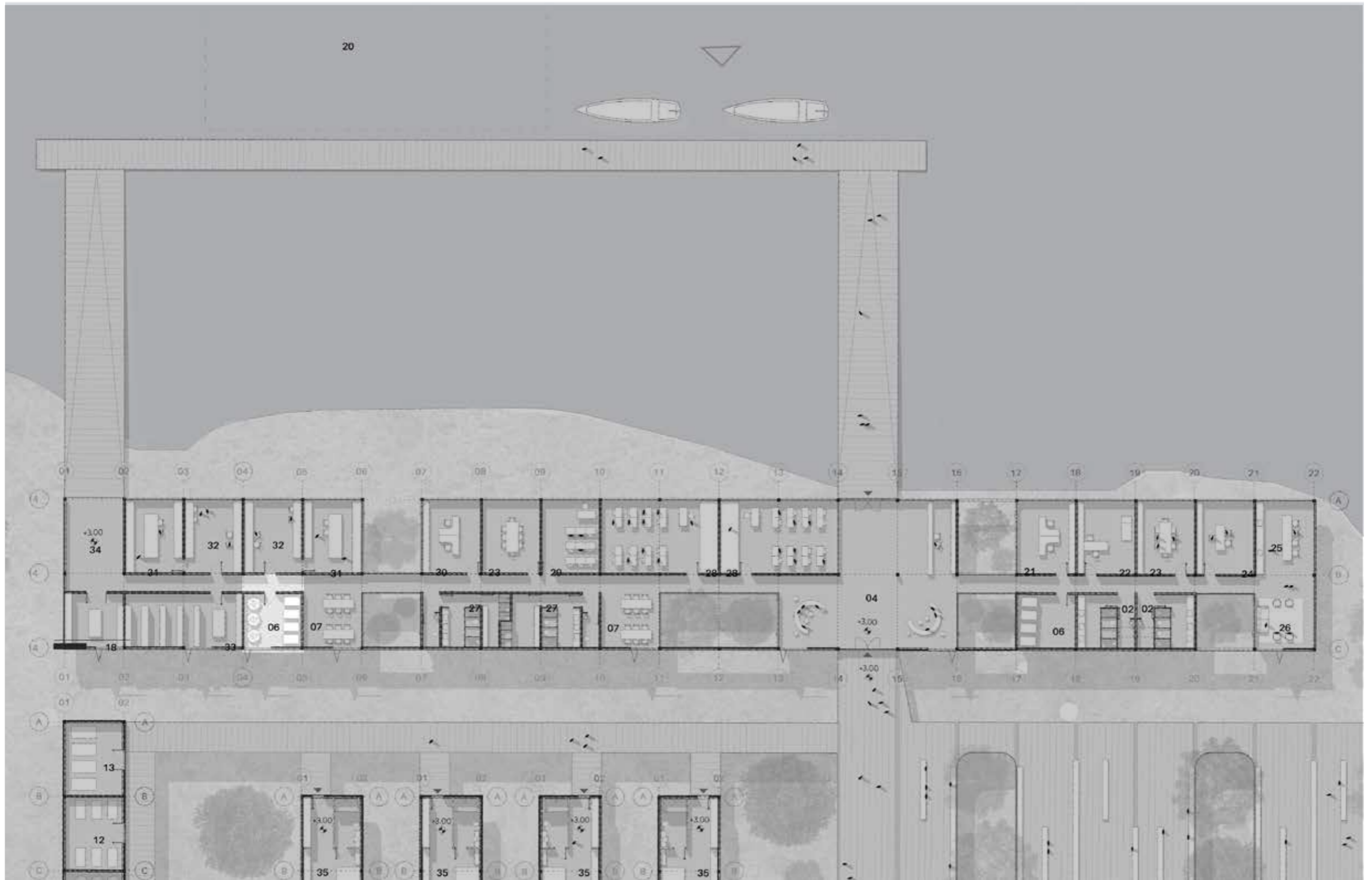

Conhecimento

arquivo/acervo museus

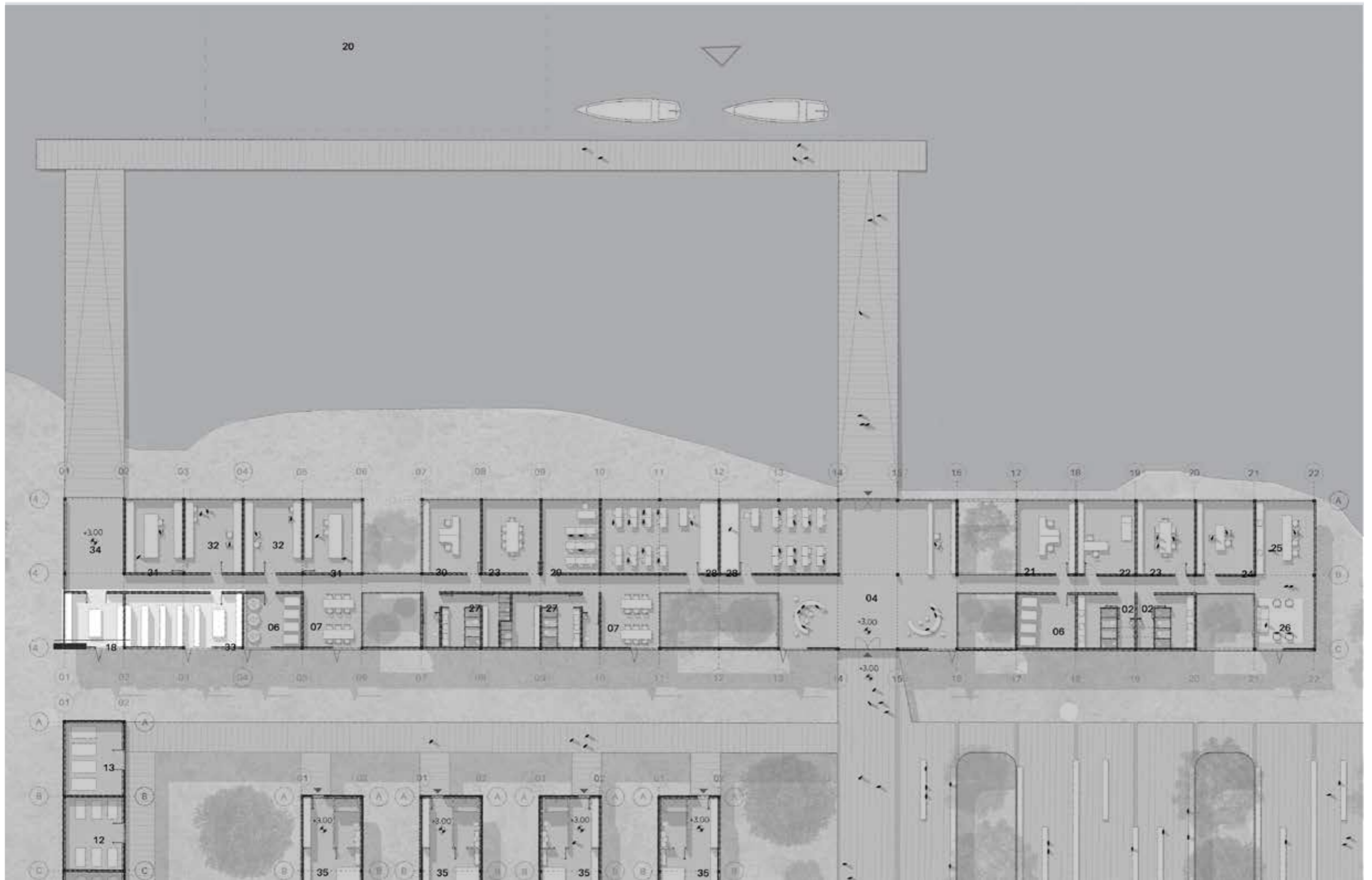

Conhecimento

pesquisa
administração



Conhecimento

dormitórios



Conhecimento

dormitórios

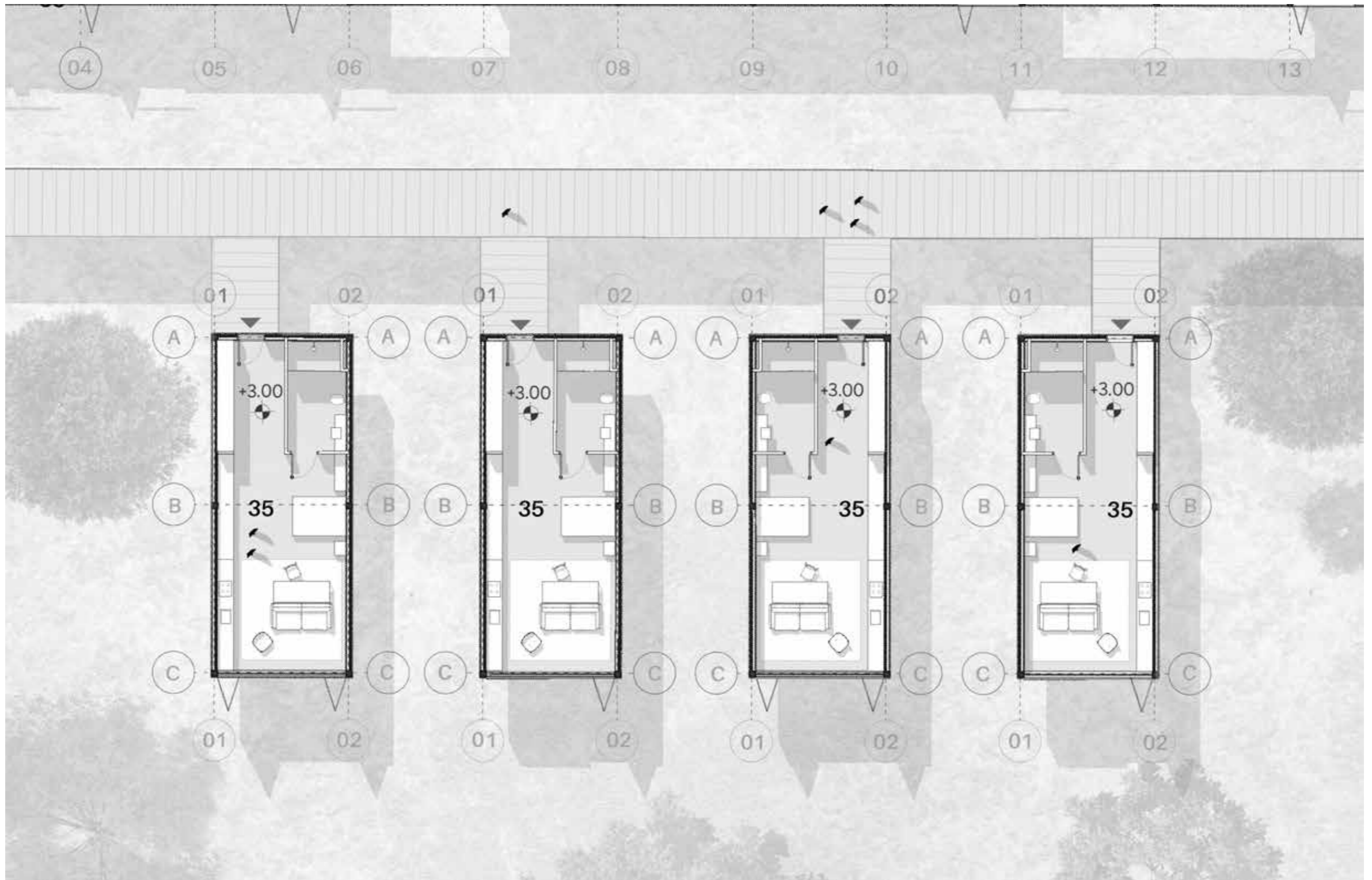

Conhecimento

refeitório



Conhecimento

refeitório



Conhecimento

Casa da Chácara:
exposições



Conhecimento

Casa da Chácara:
exposições

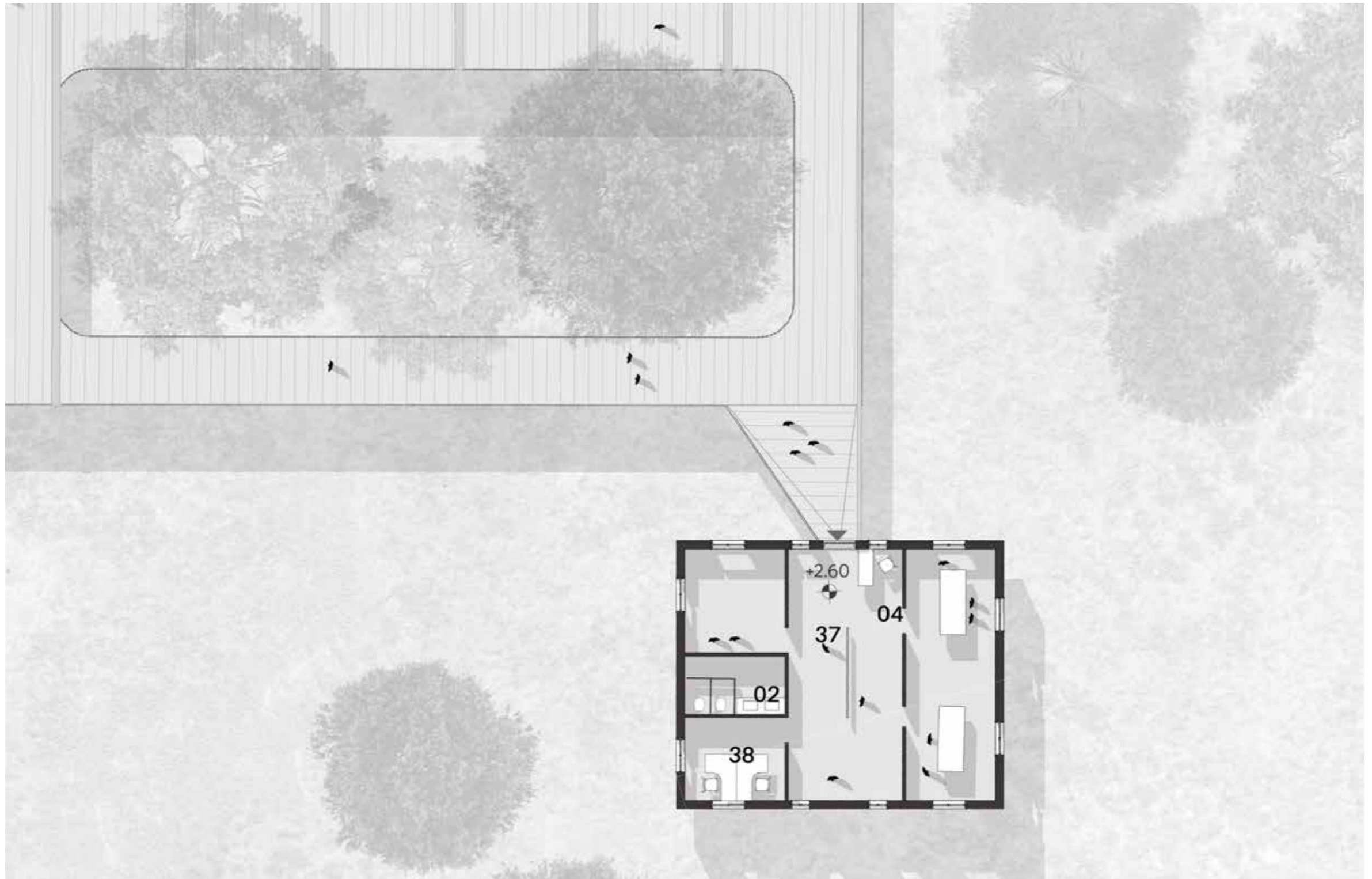

Conhecimento

planta baixa



Conhecimento

Fachada norte

Corte longitudinal edifício pesquisa + administração

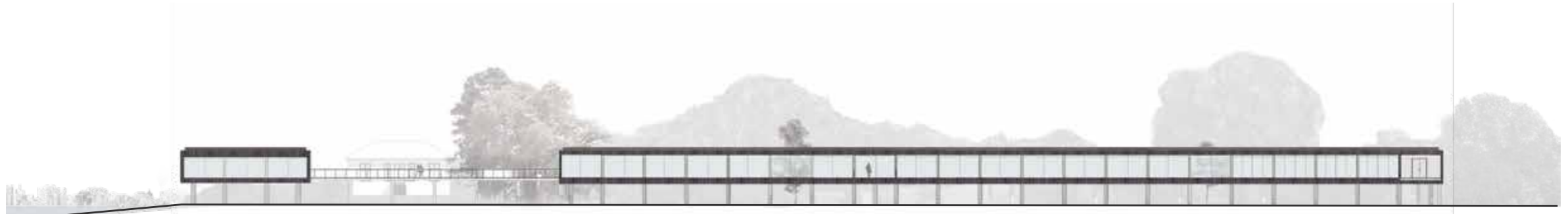

Conhecimento

vista da chegada pela trilha



Conhecimento



Paisagem

Partido Geral
Centro paisagem

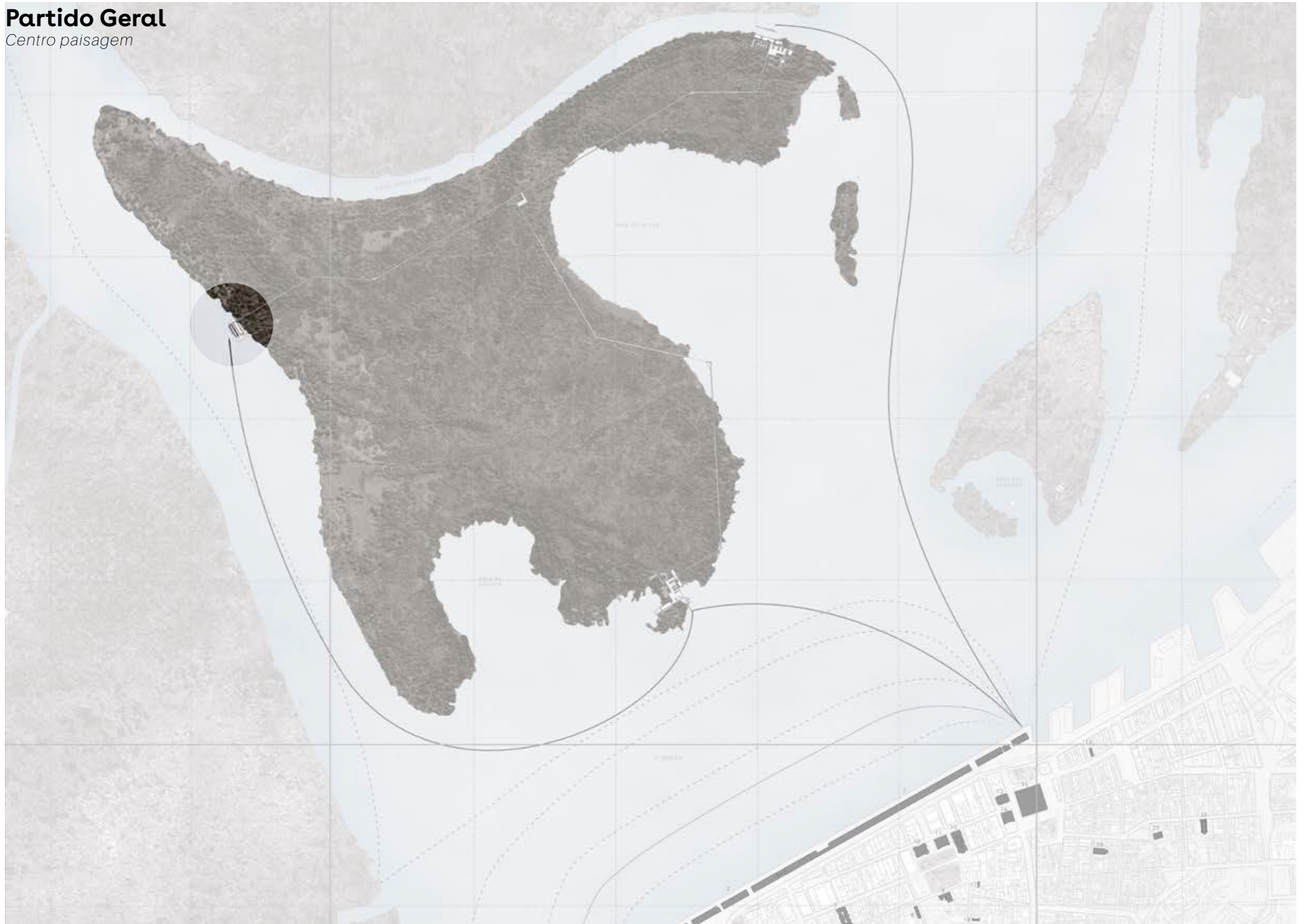

Paisagem

posicionamento do programa

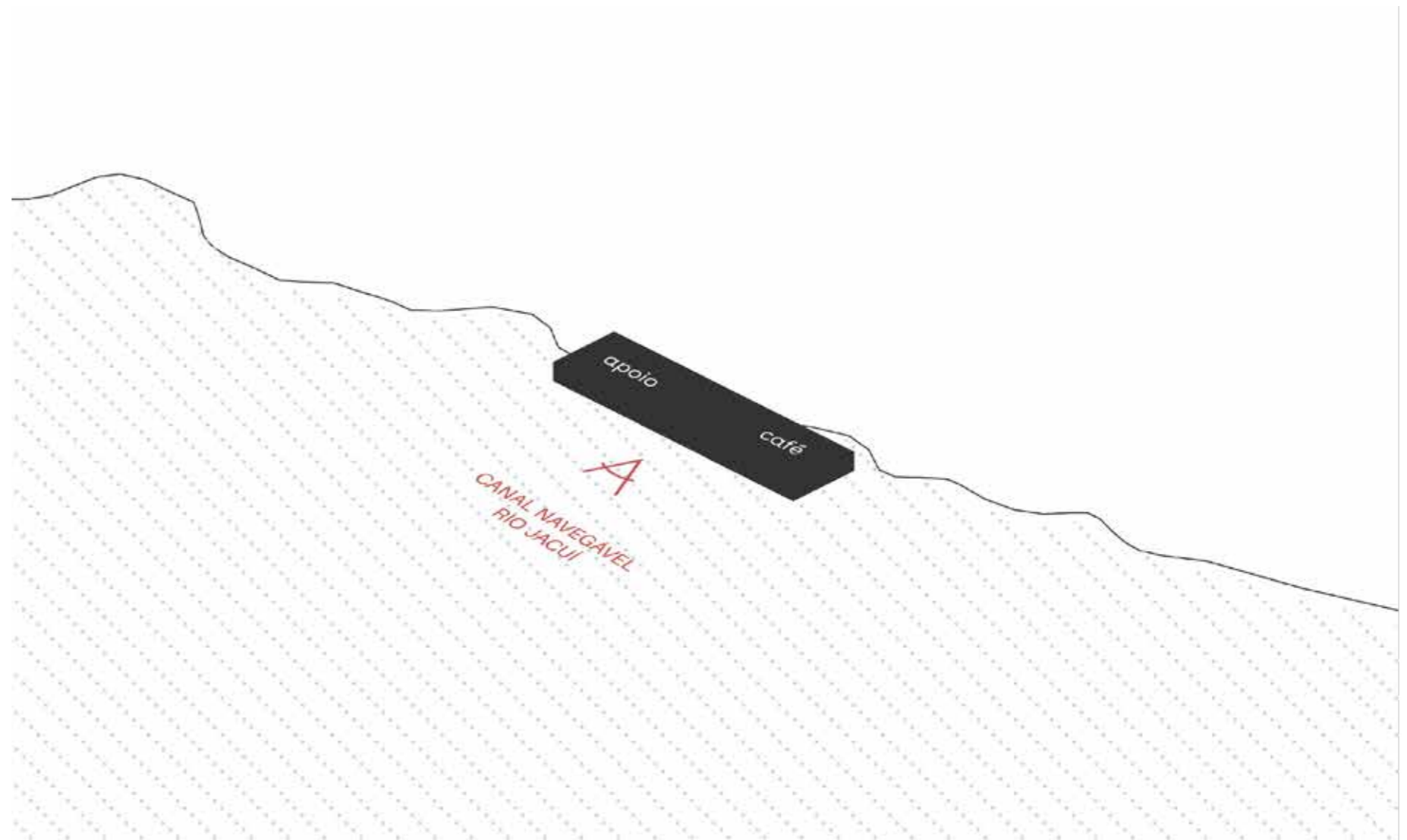

Paisagem

posicionamento do programa

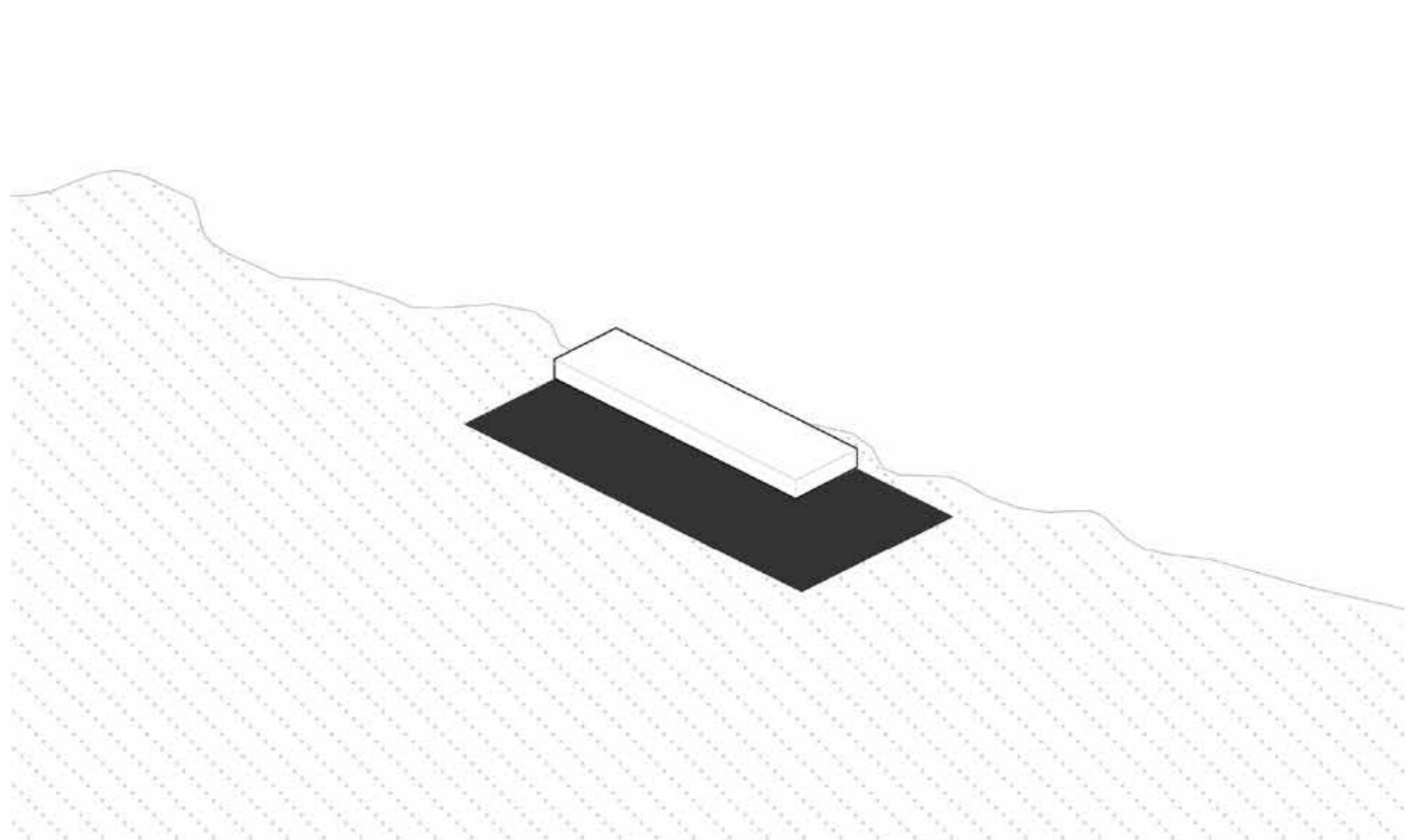

Paisagem

posicionamento do programa

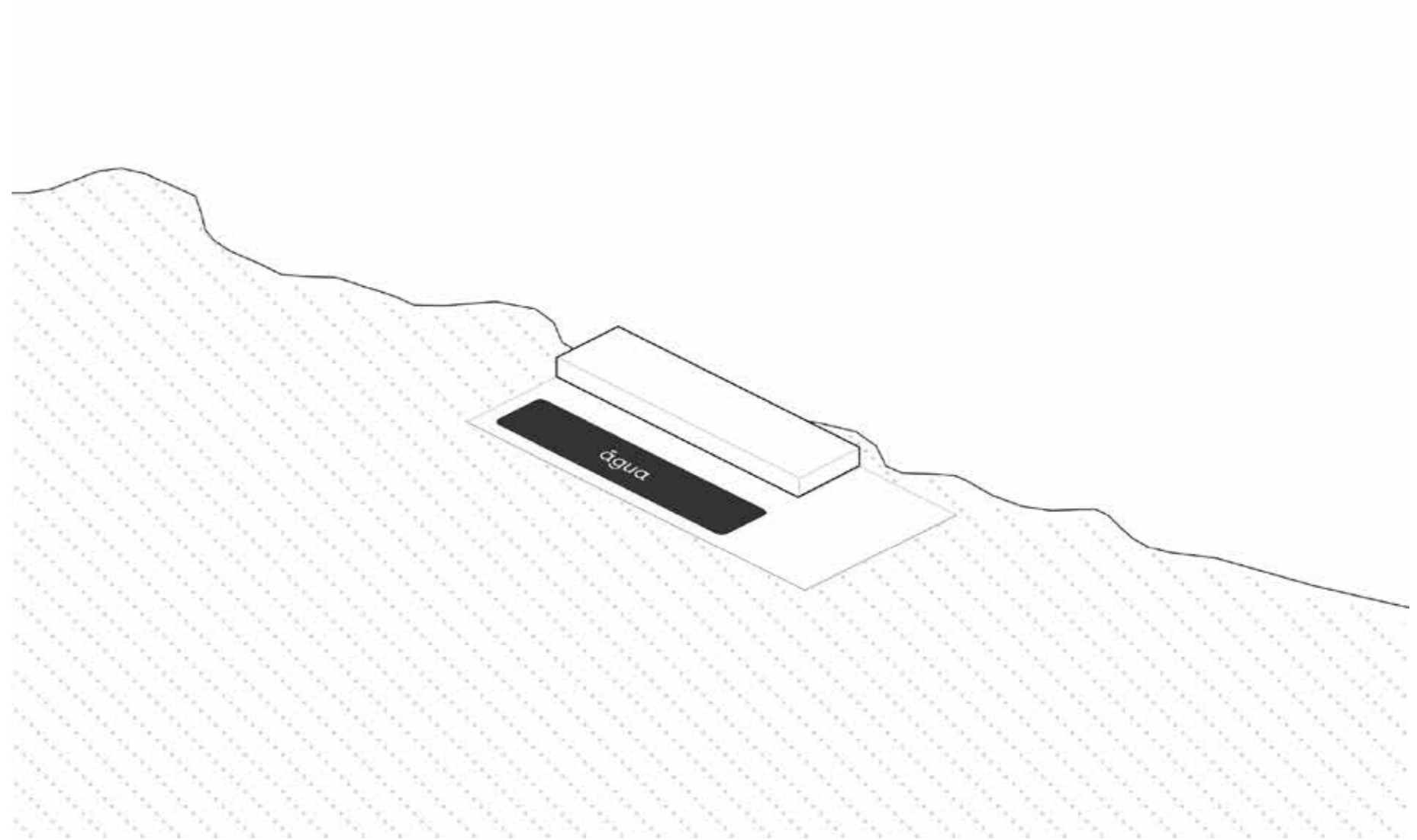

Paisagem

implantação

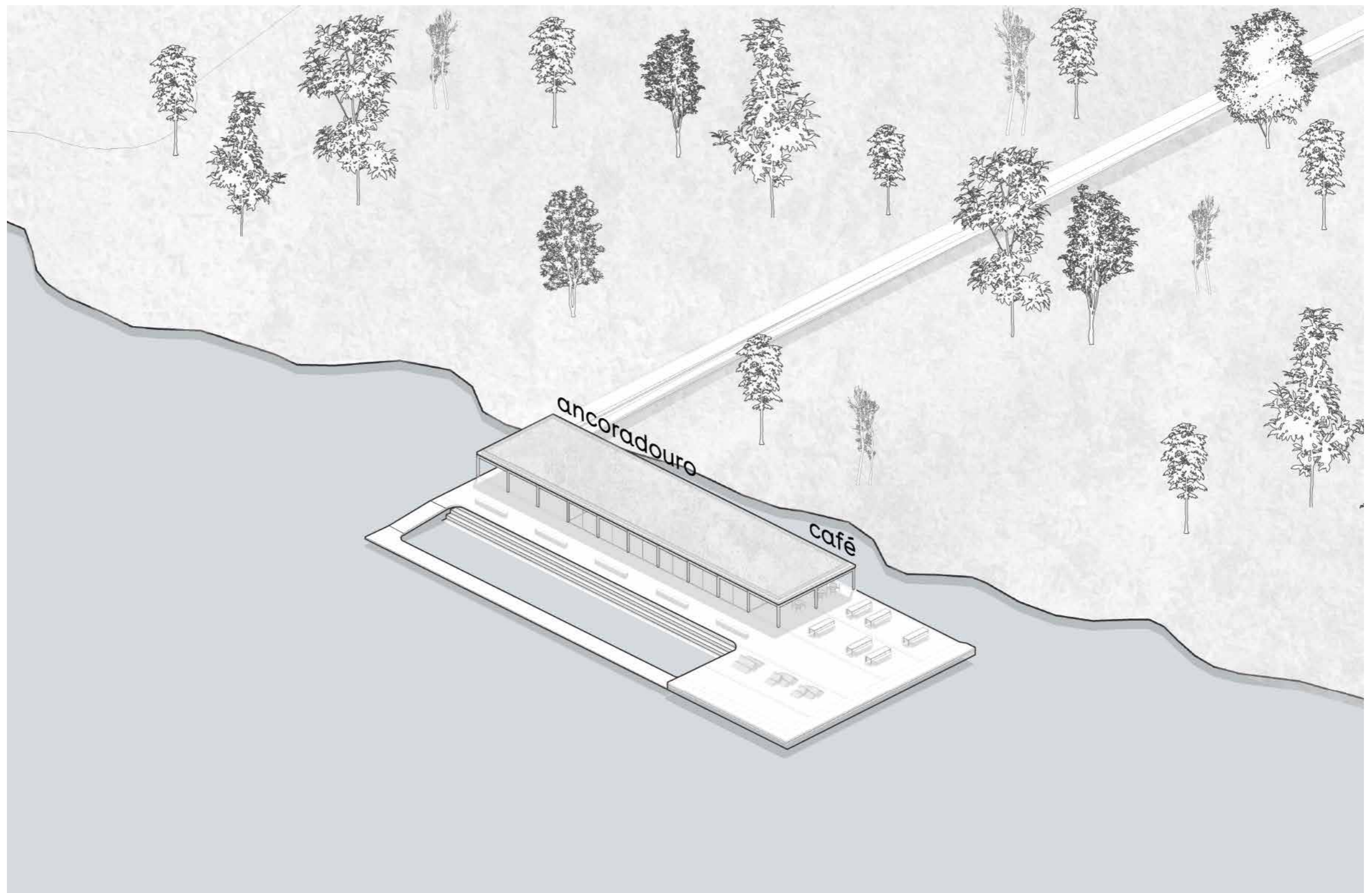

Paisagem

planta baixa

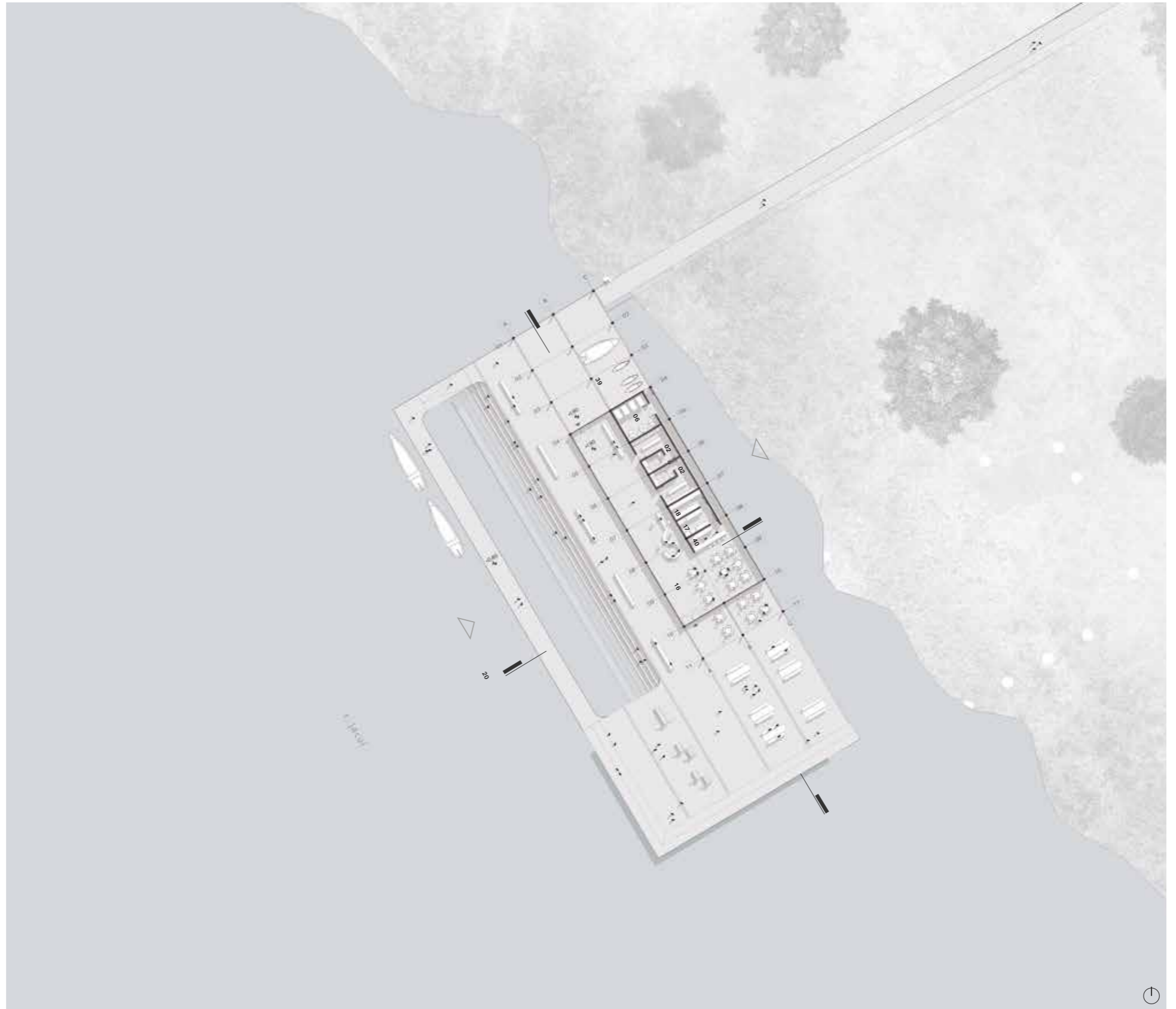

Paisagem

apoio e café

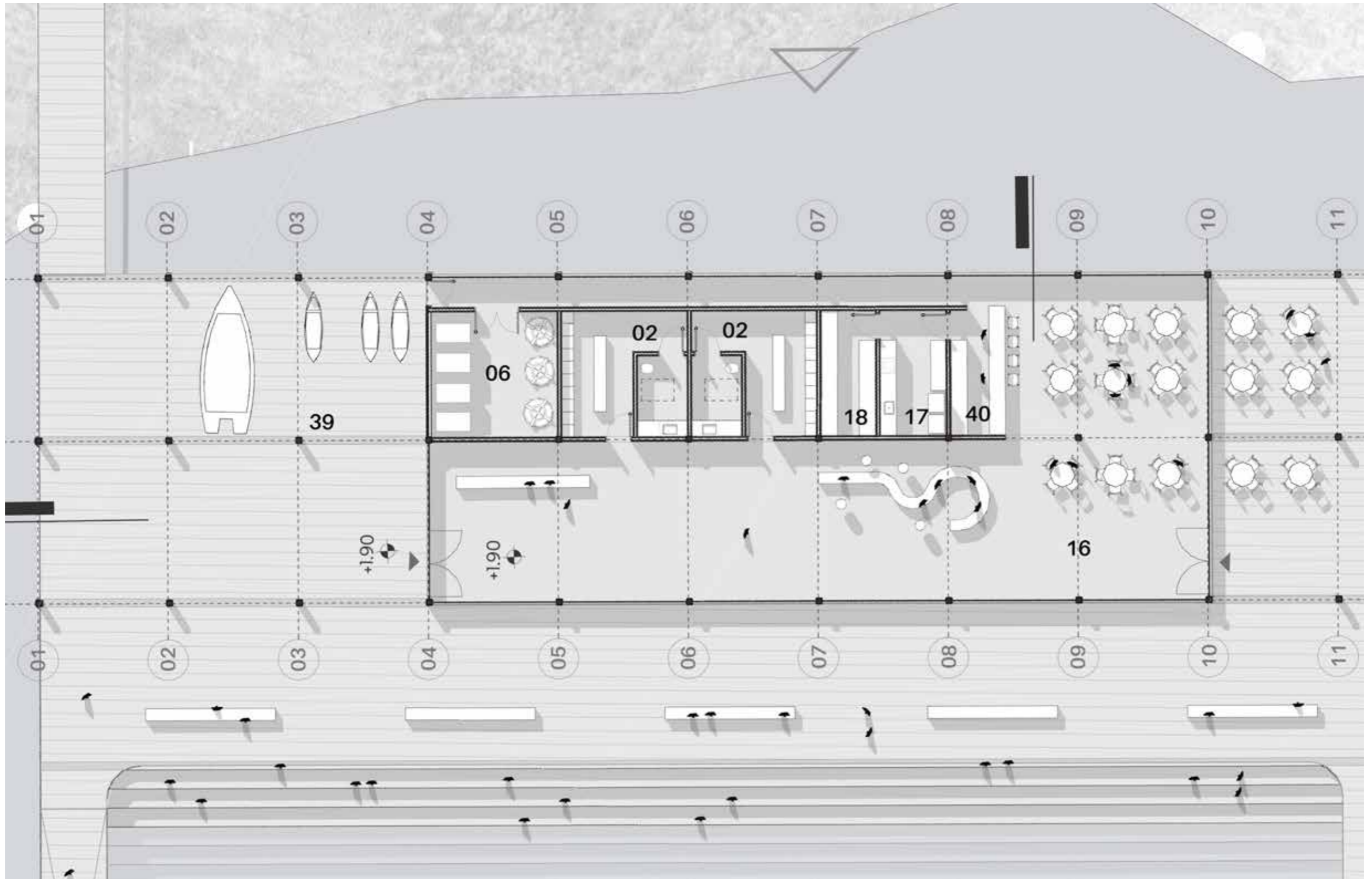

Paisagem

depósito barcos

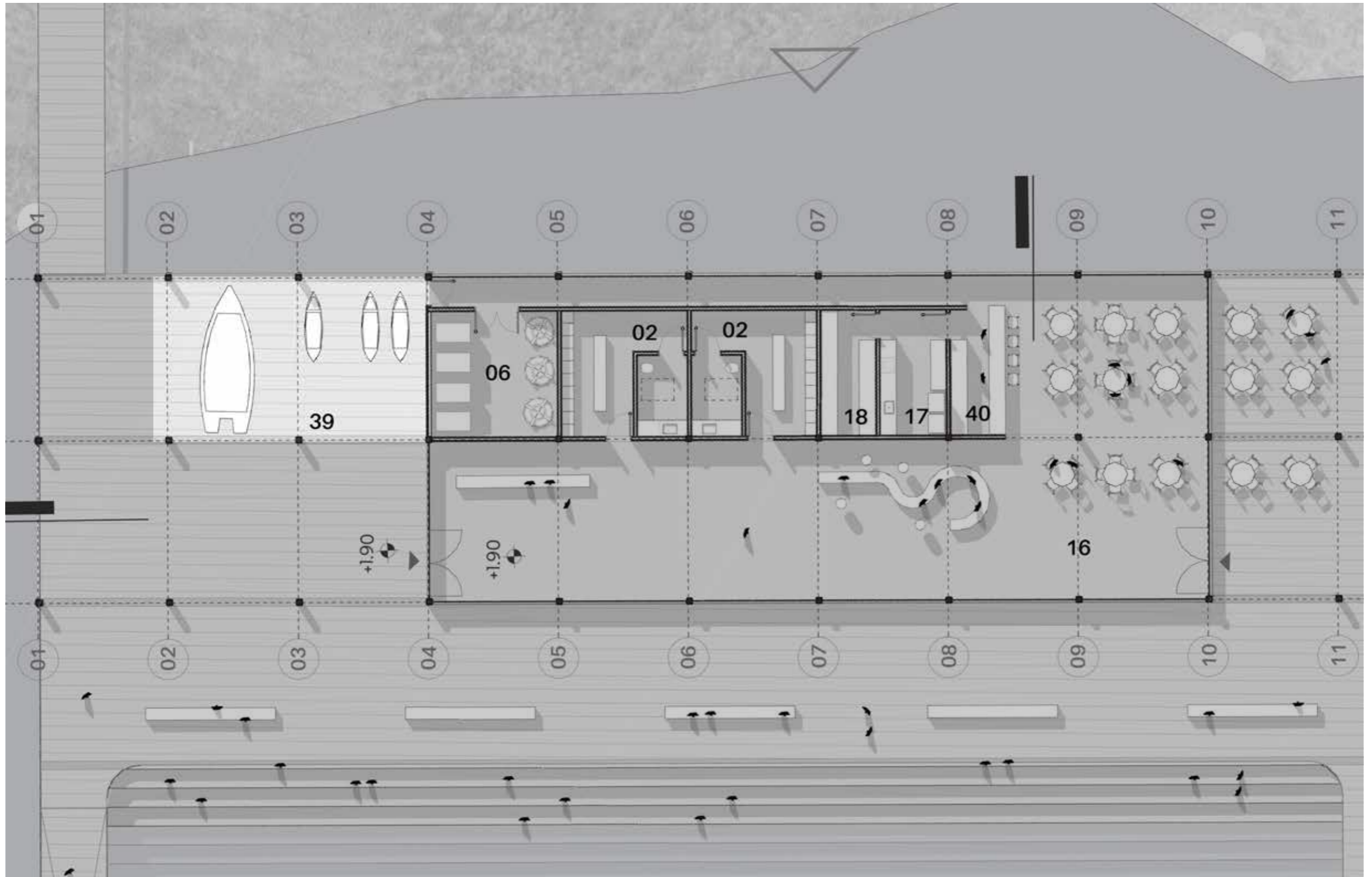

Paisagem

área técnica

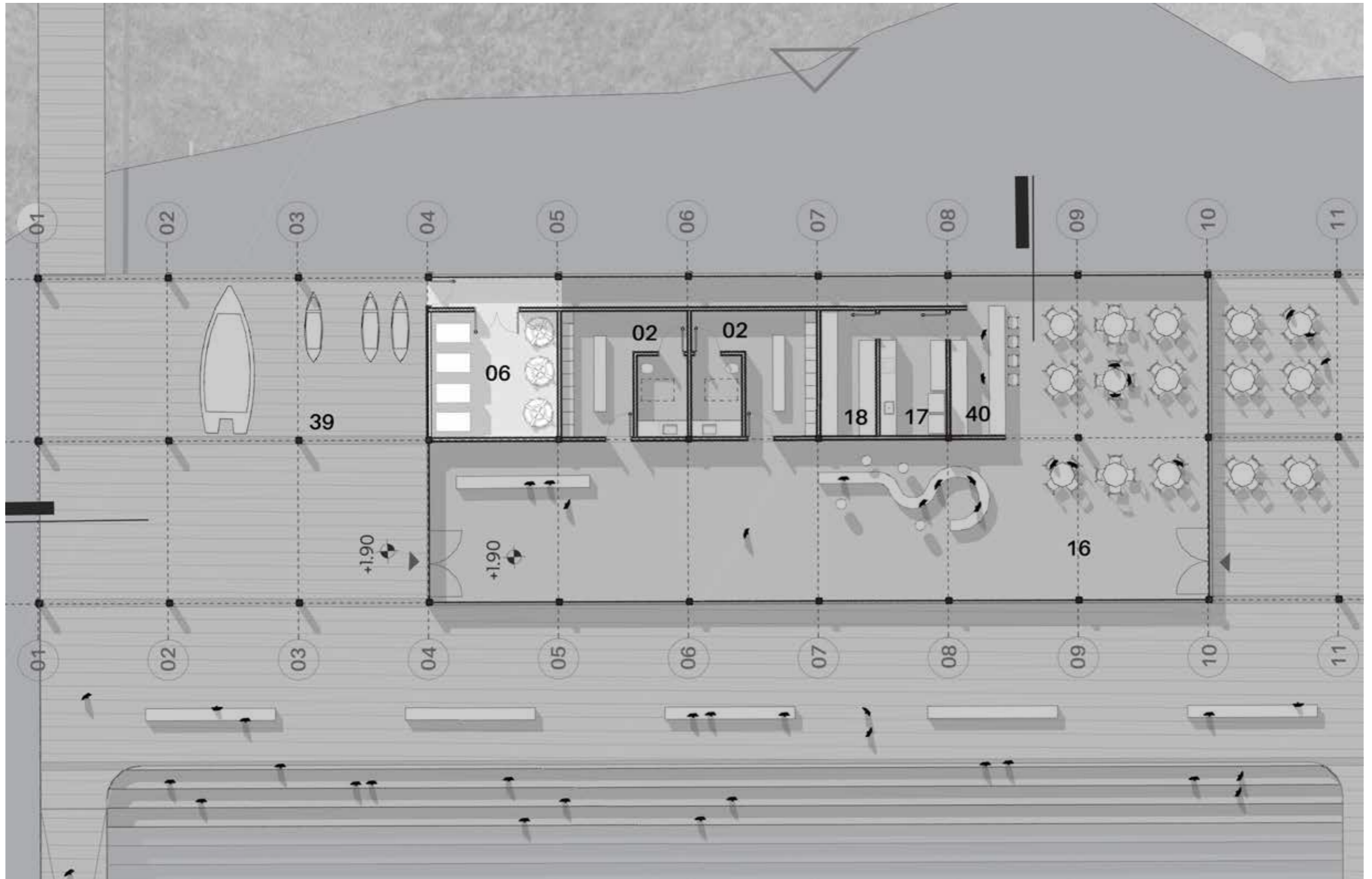

Paisagem

sanitários e vestiários

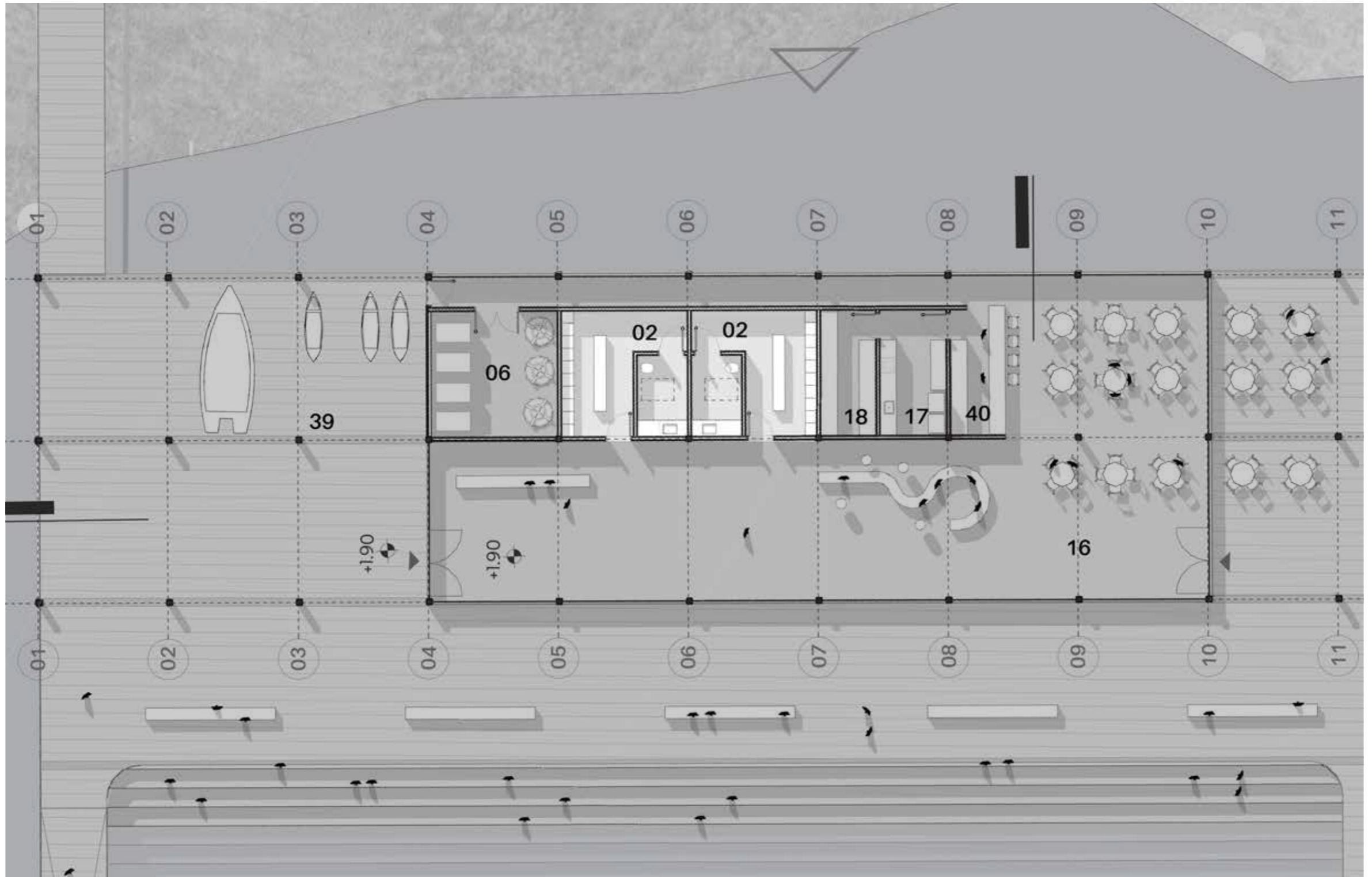

Paisagem

depósito

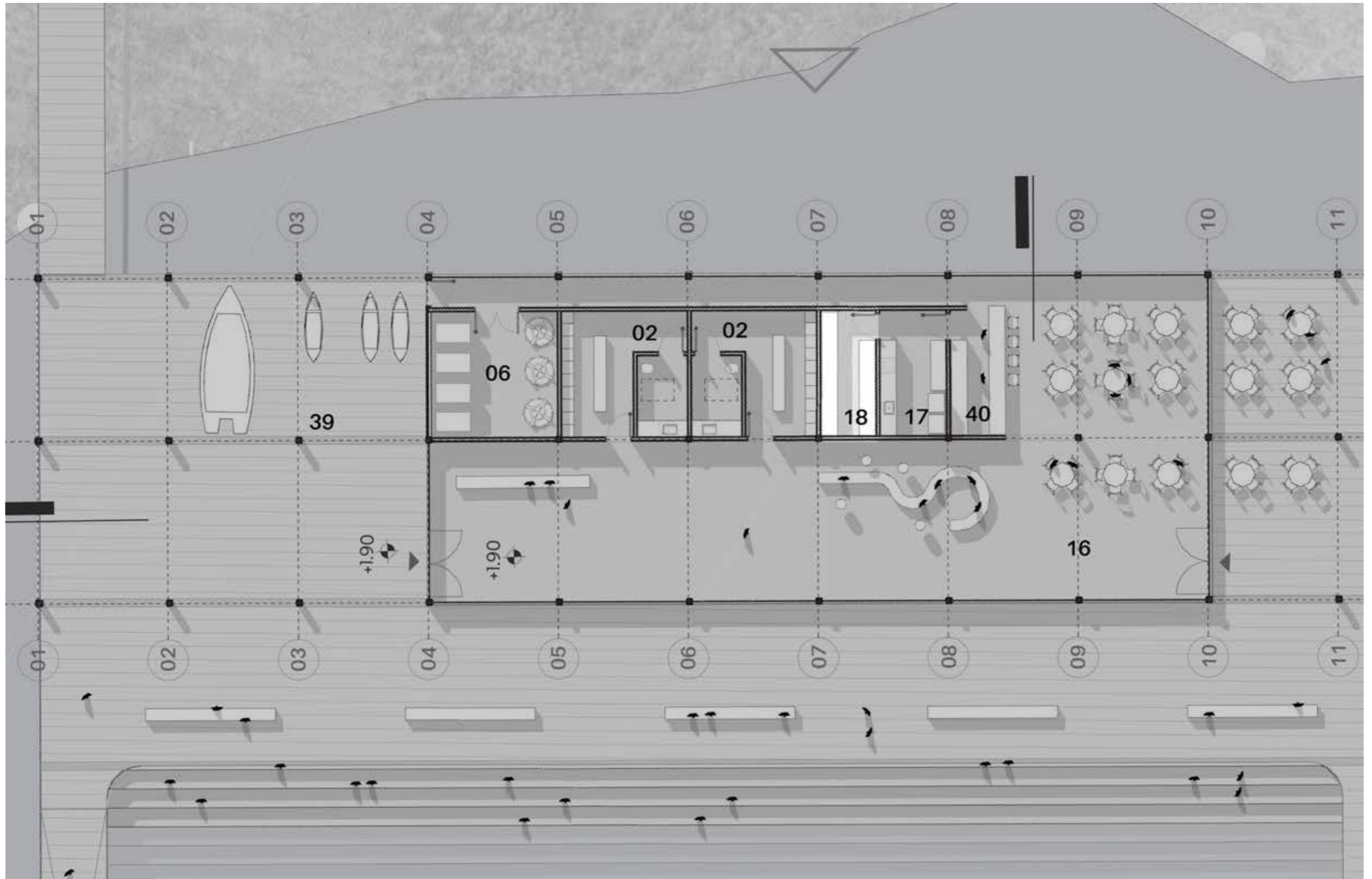

Paisagem

cozinha

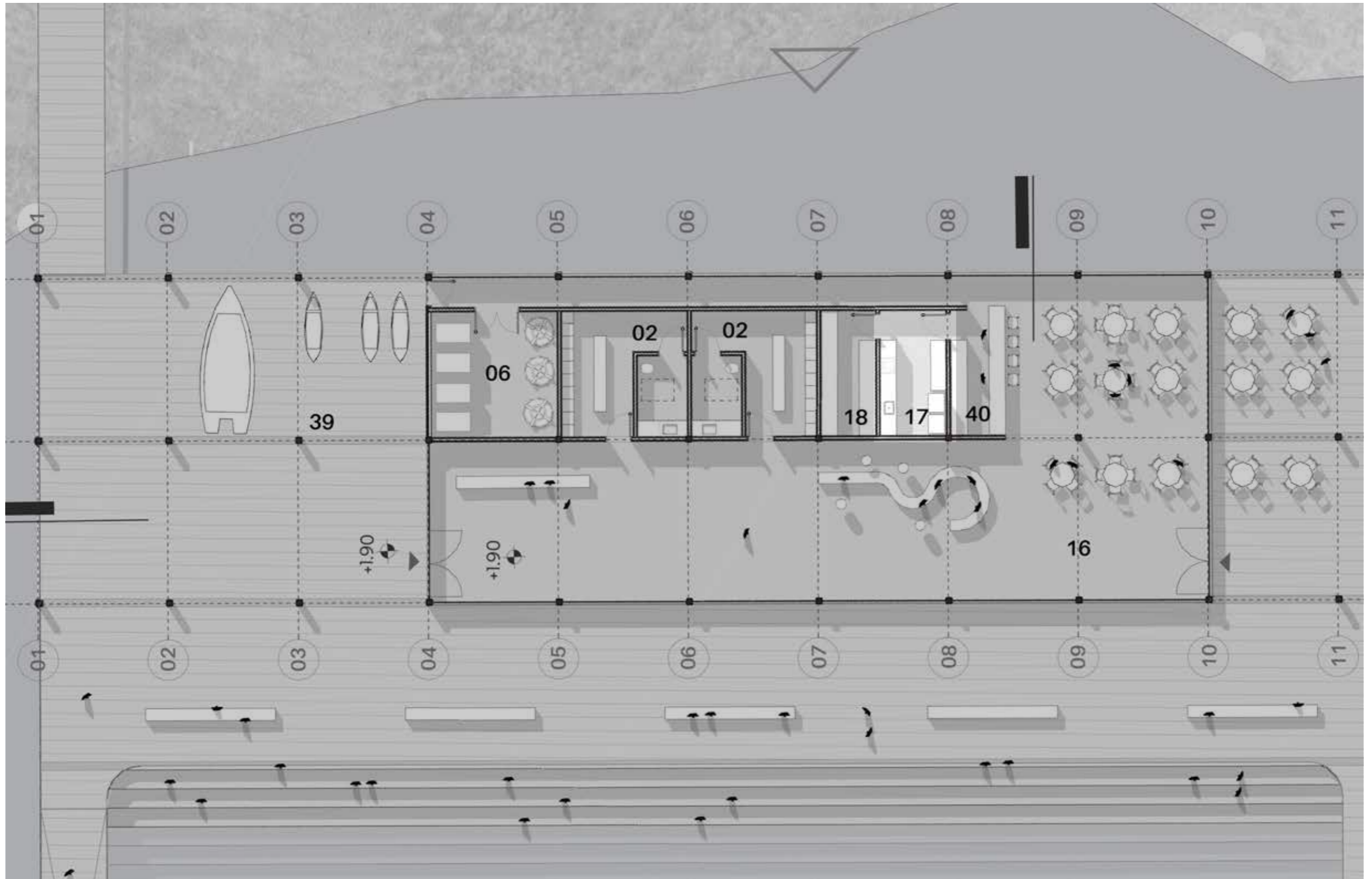

Paisagem

café/bistrô

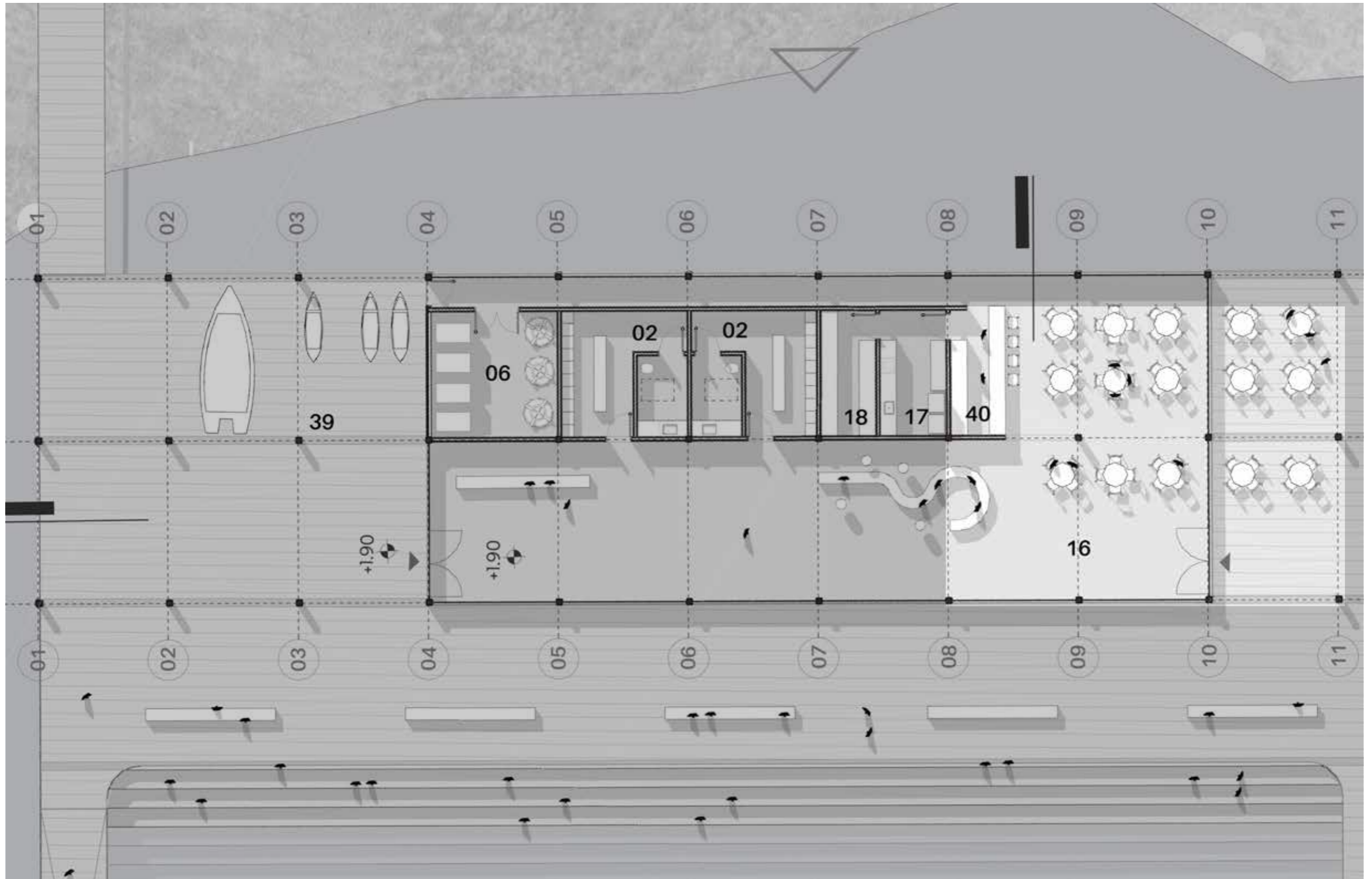

Paisagem

planta baixa

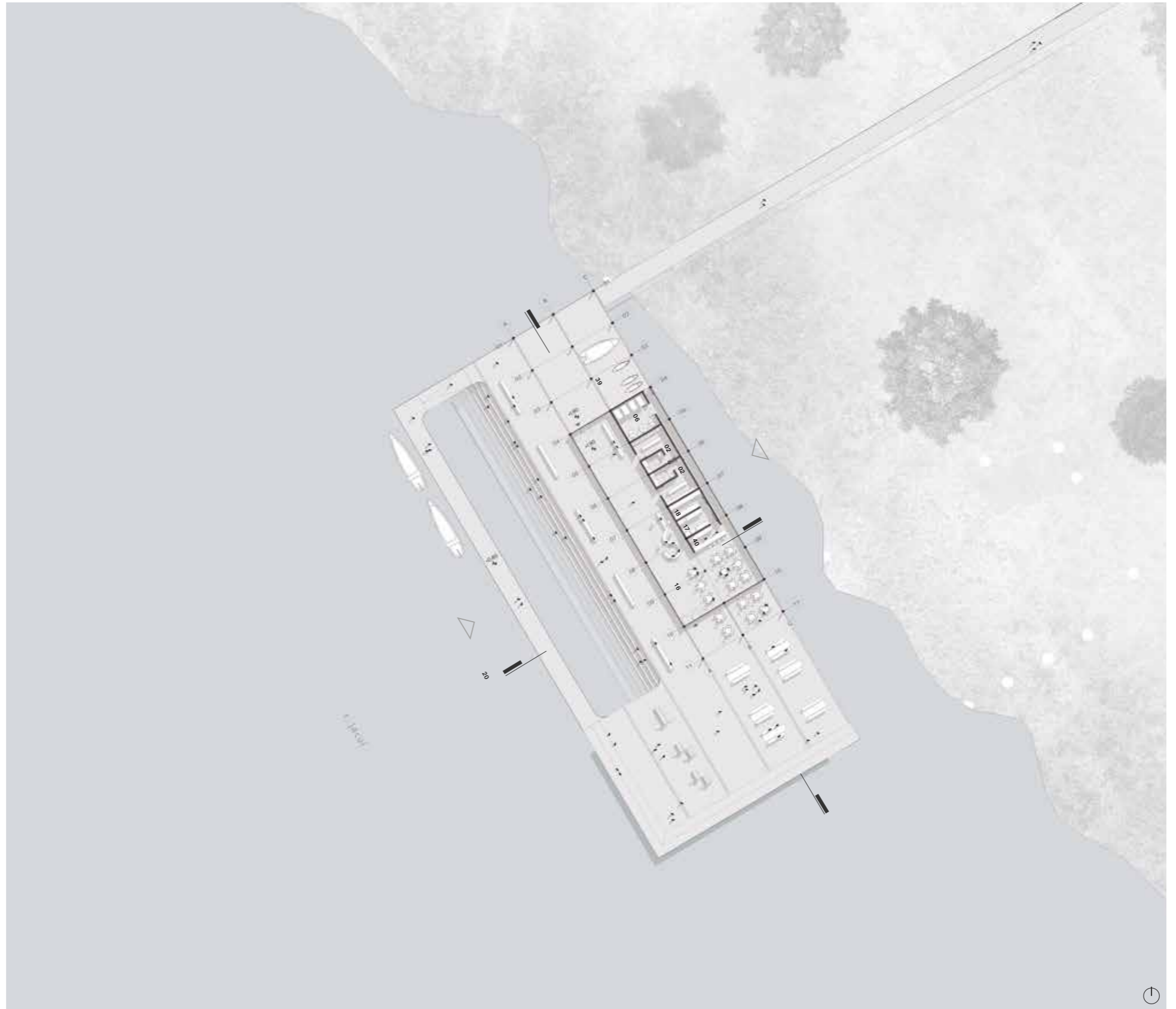

Paisagem

Fachada sudoeste
Fachada nordeste
Corte transversal
Corte longitudinal



Paisagem



Trilhas mirante

Partido Geral

trilhas e mirante



Partido Geral

trilhas e mirante



Trilhas e Mirante

chegada dos centros



paisagem

conhecimento

memória

Trilhas e Mirante

praça que organiza

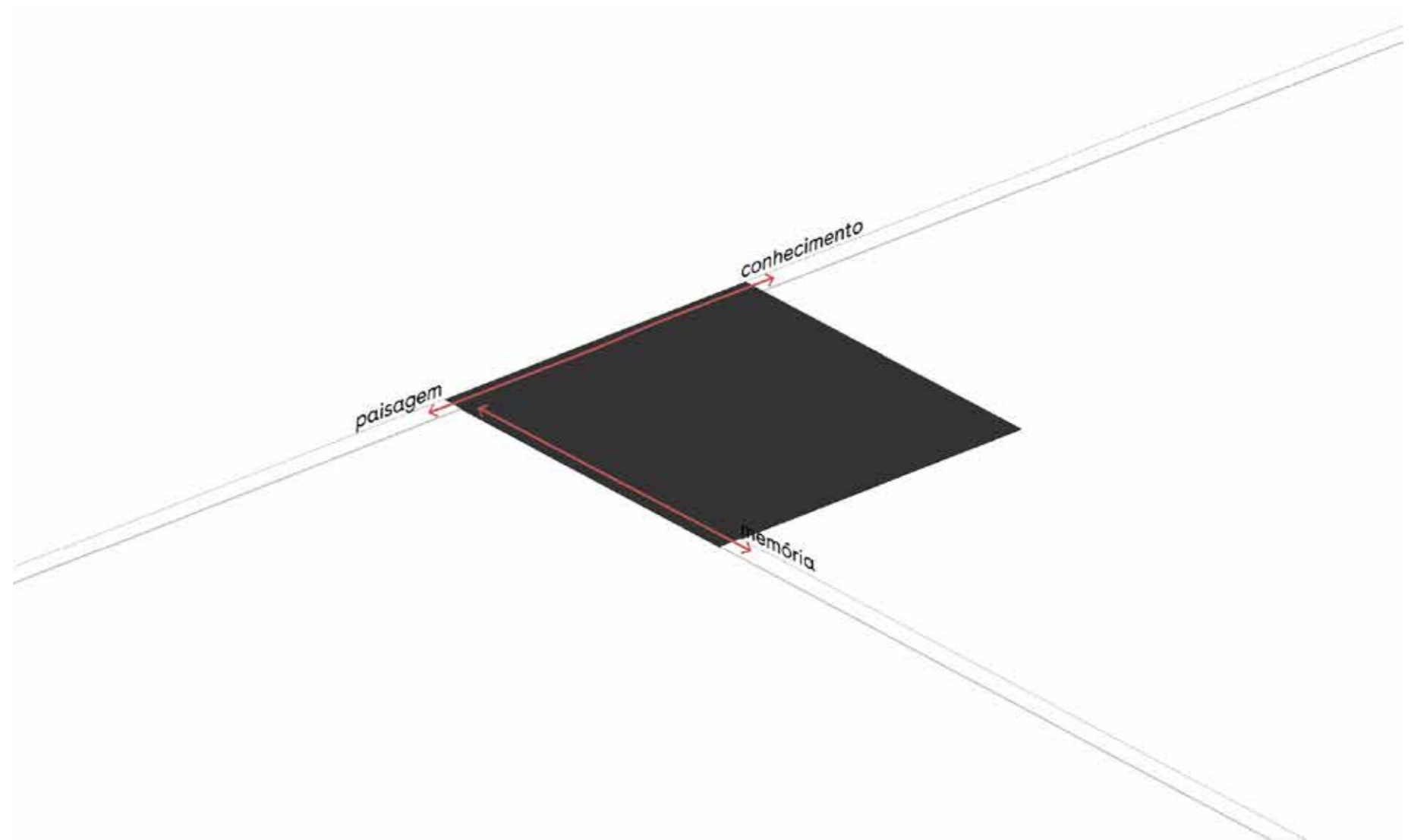

Trilhas e Mirante

subtração

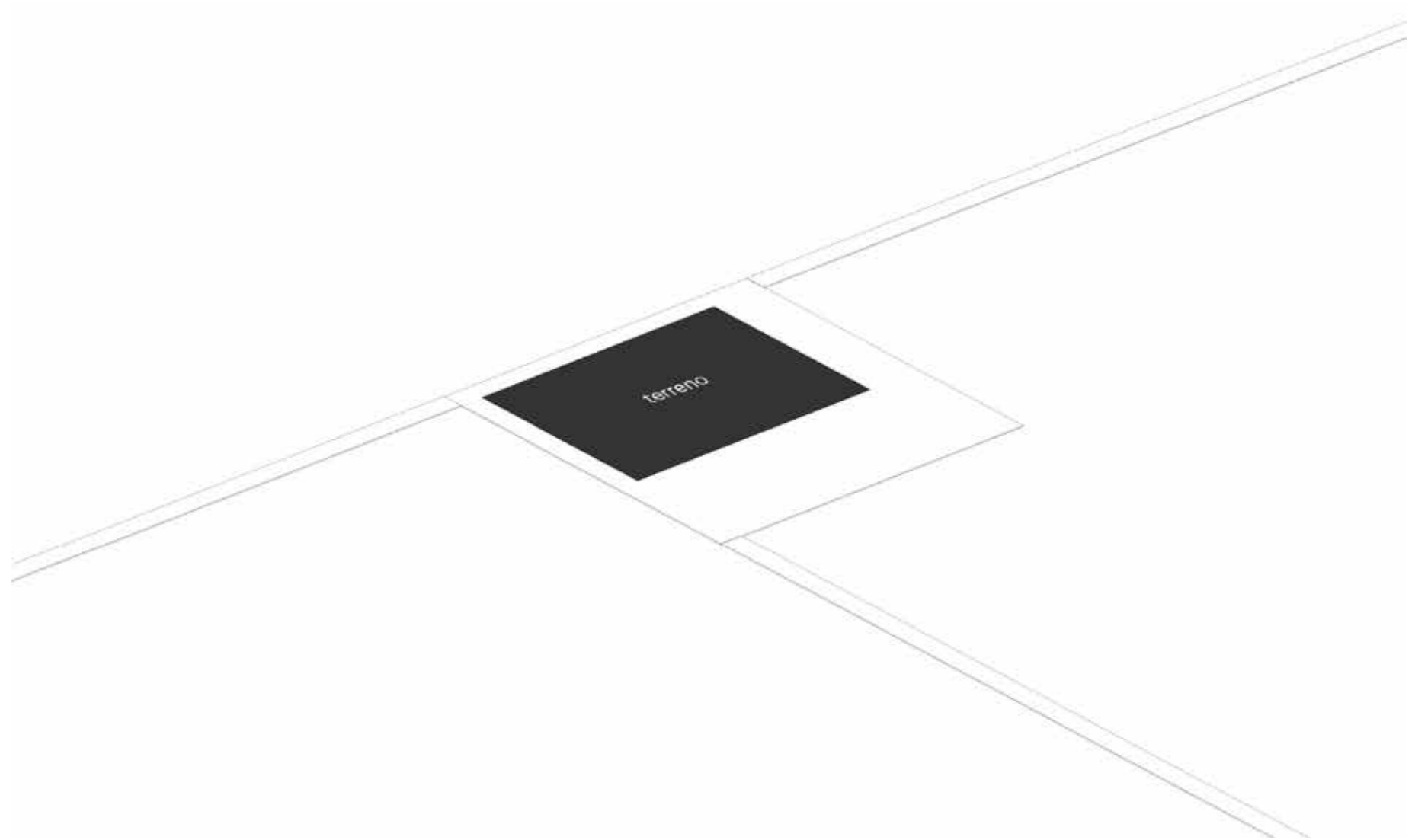

Trilhas e Mirante

posicionamento módulo estrutural

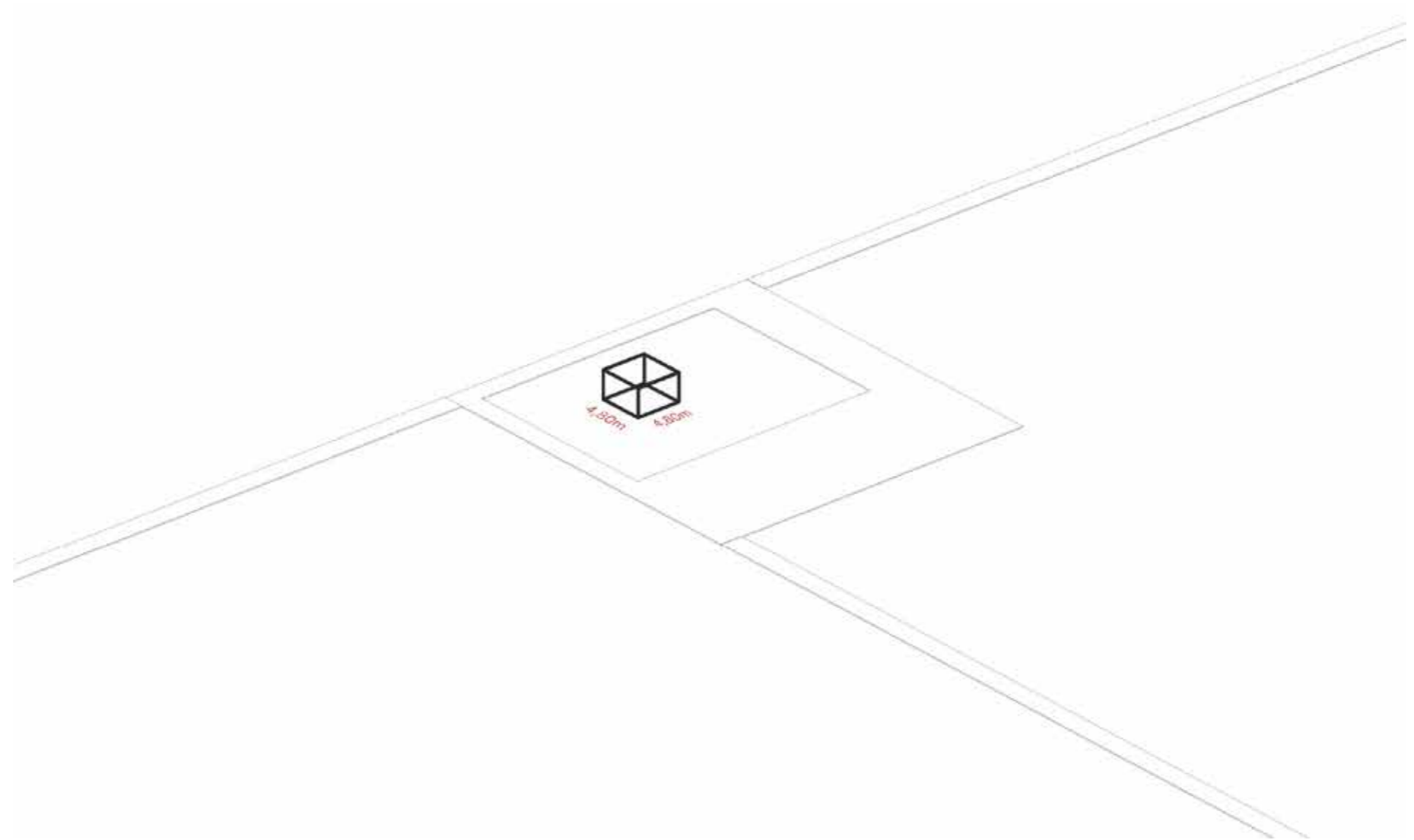

Trilhas e Mirante

replicação vertical do módulo estrutural

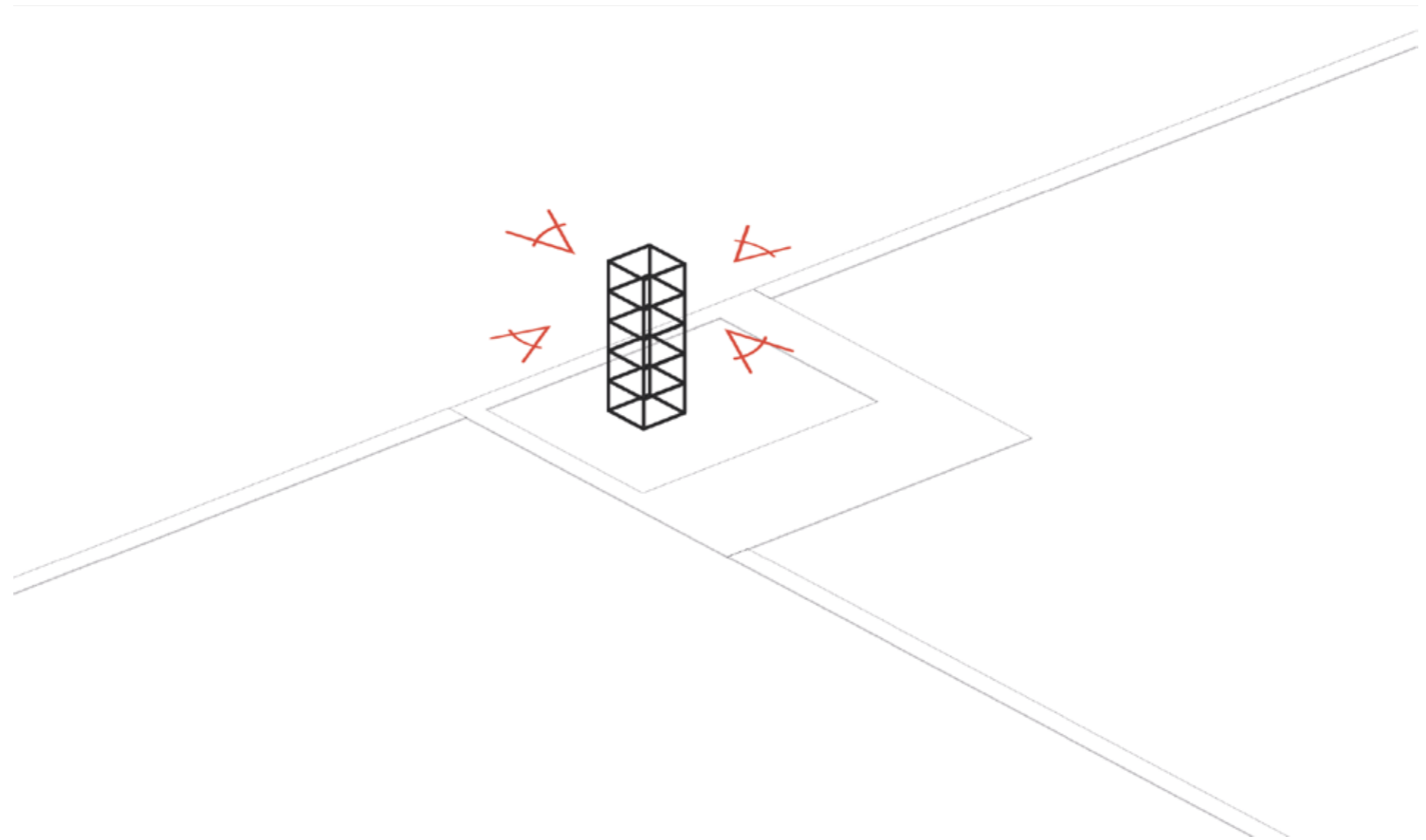

Partido Geral

planta baixa mirante, praça e estar

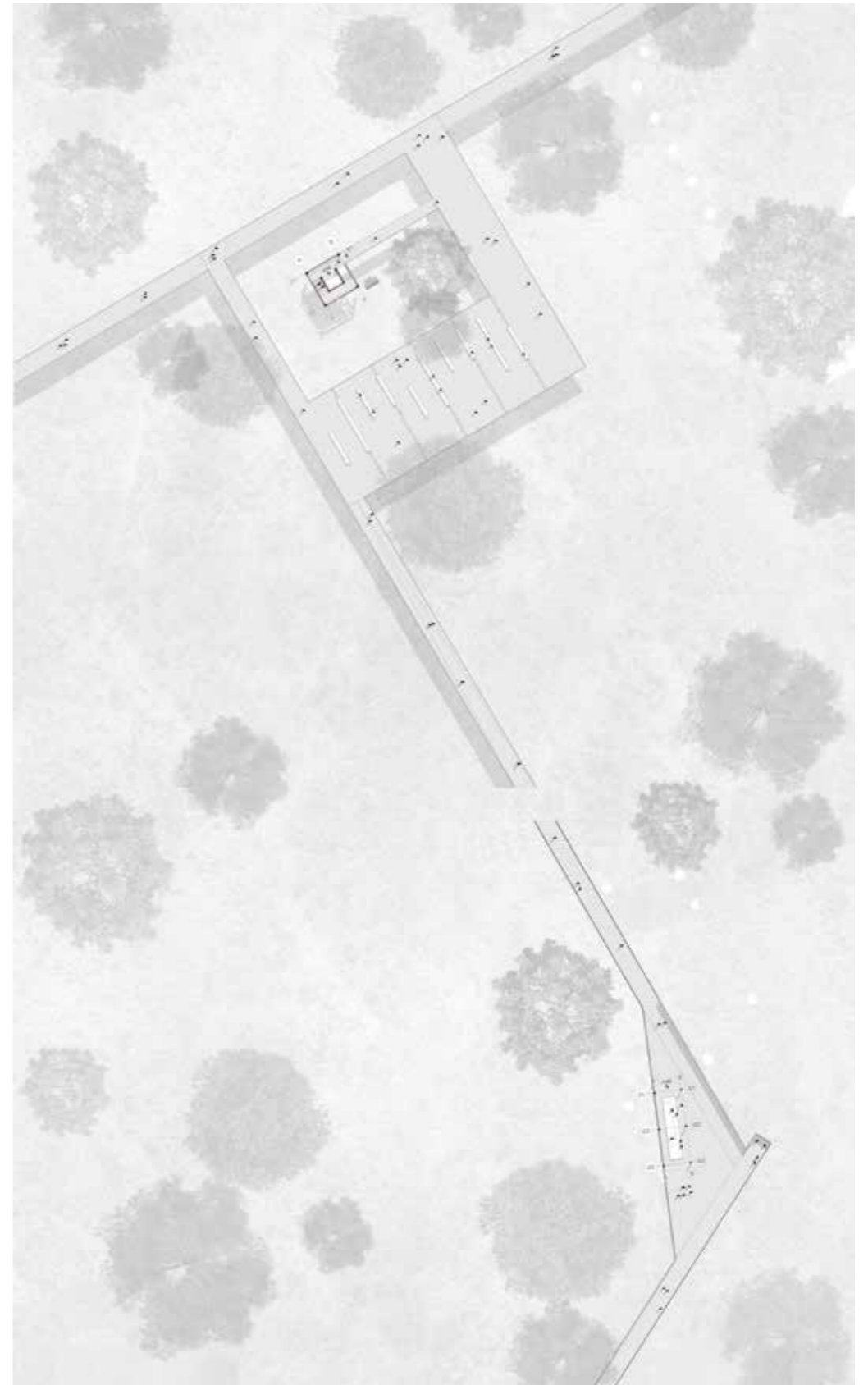

Trilhas e Mirante

praça e mirante

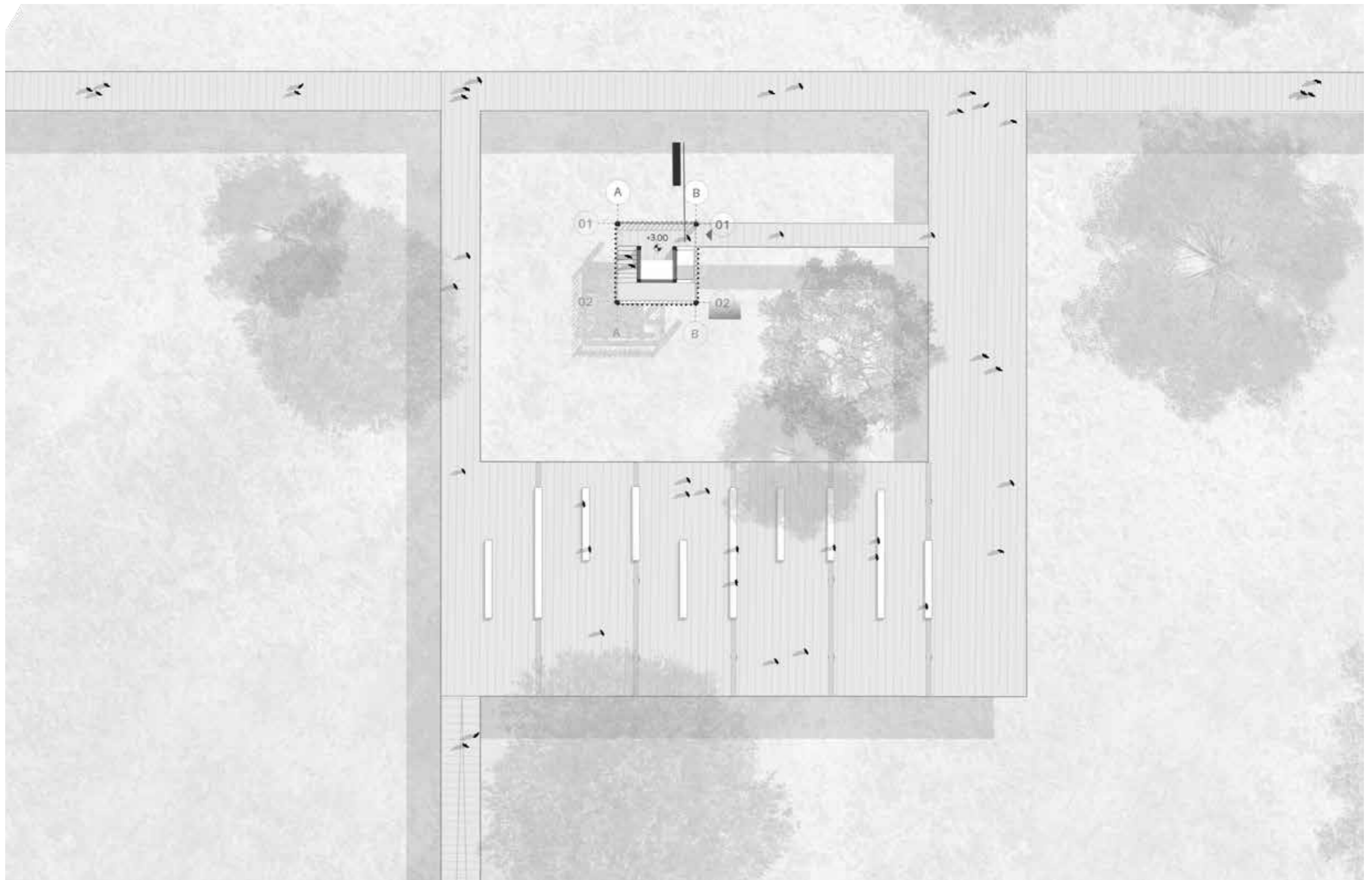

Trilhas e Mirante

corte mirante

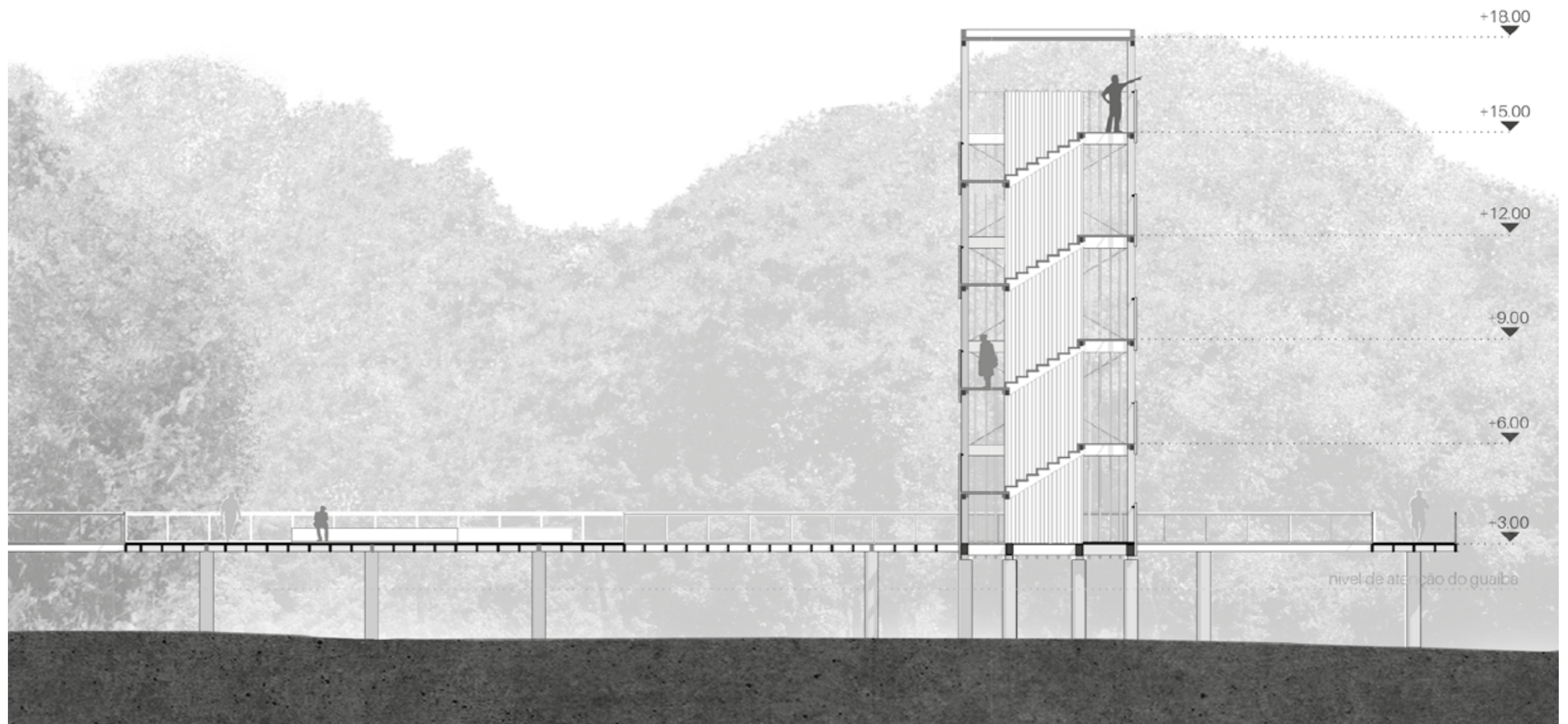

Trilhas e Mirante

corte mirante

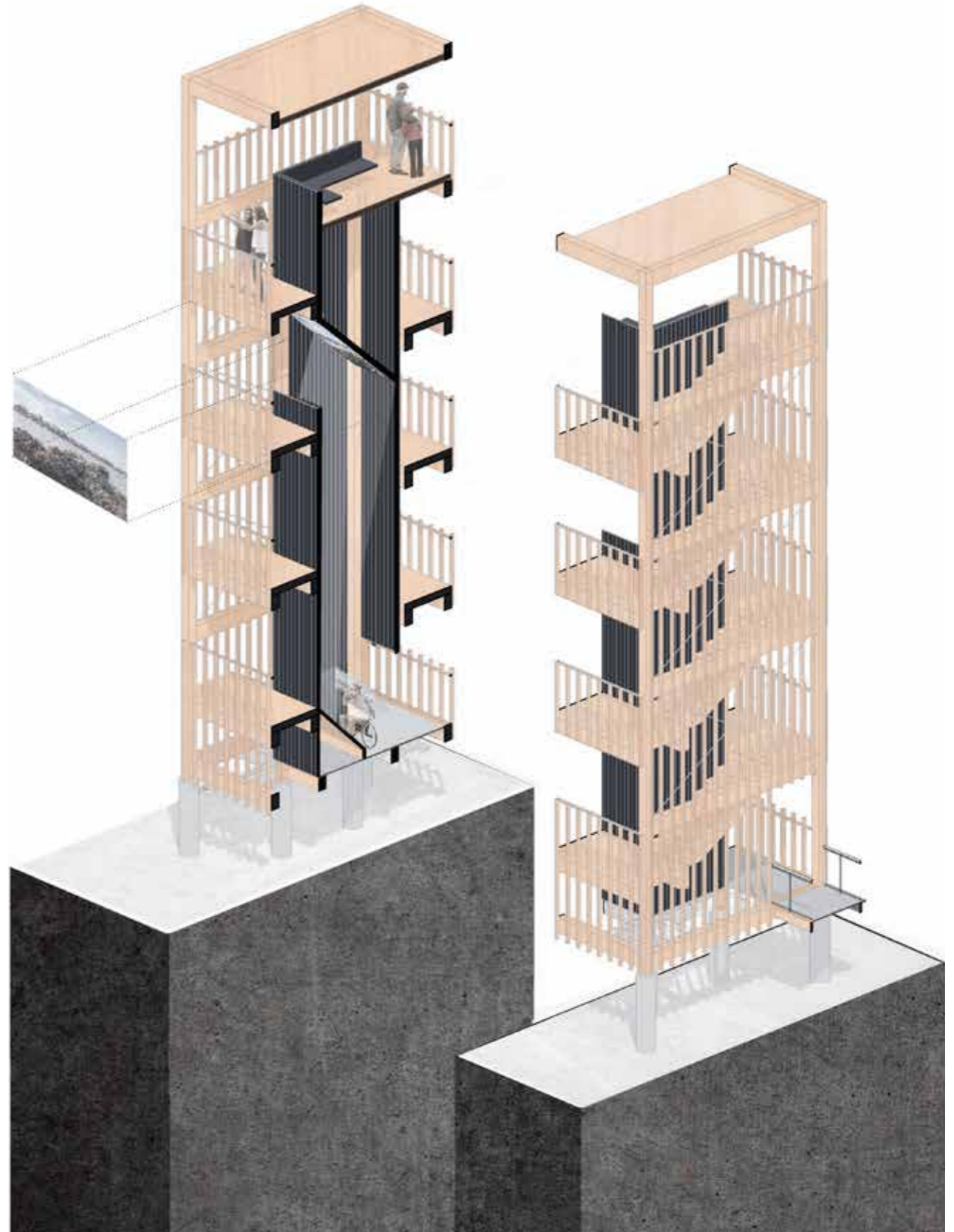

Trilhas e Mirante

estar

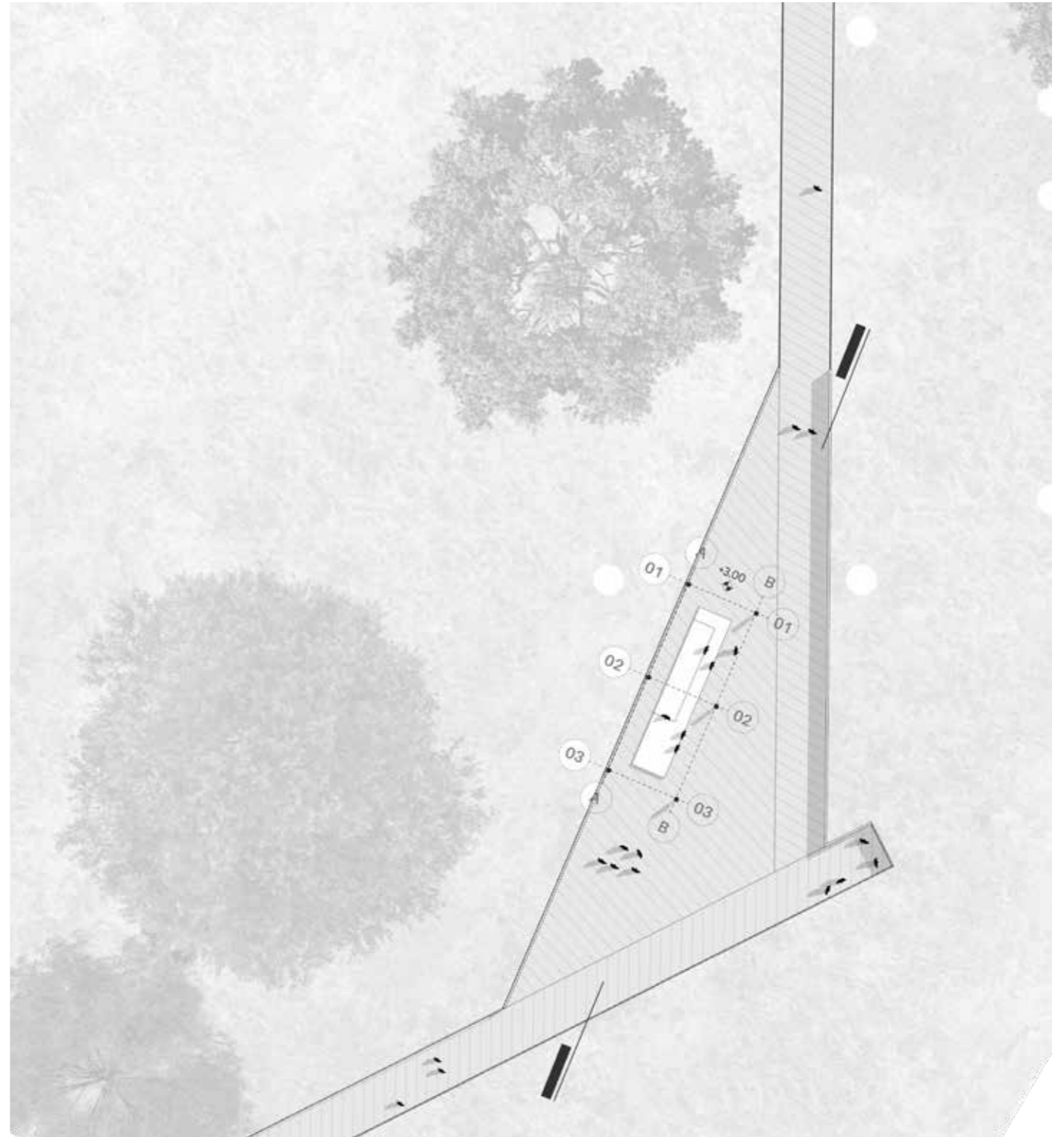

Trilhas e Mirante

corte estar

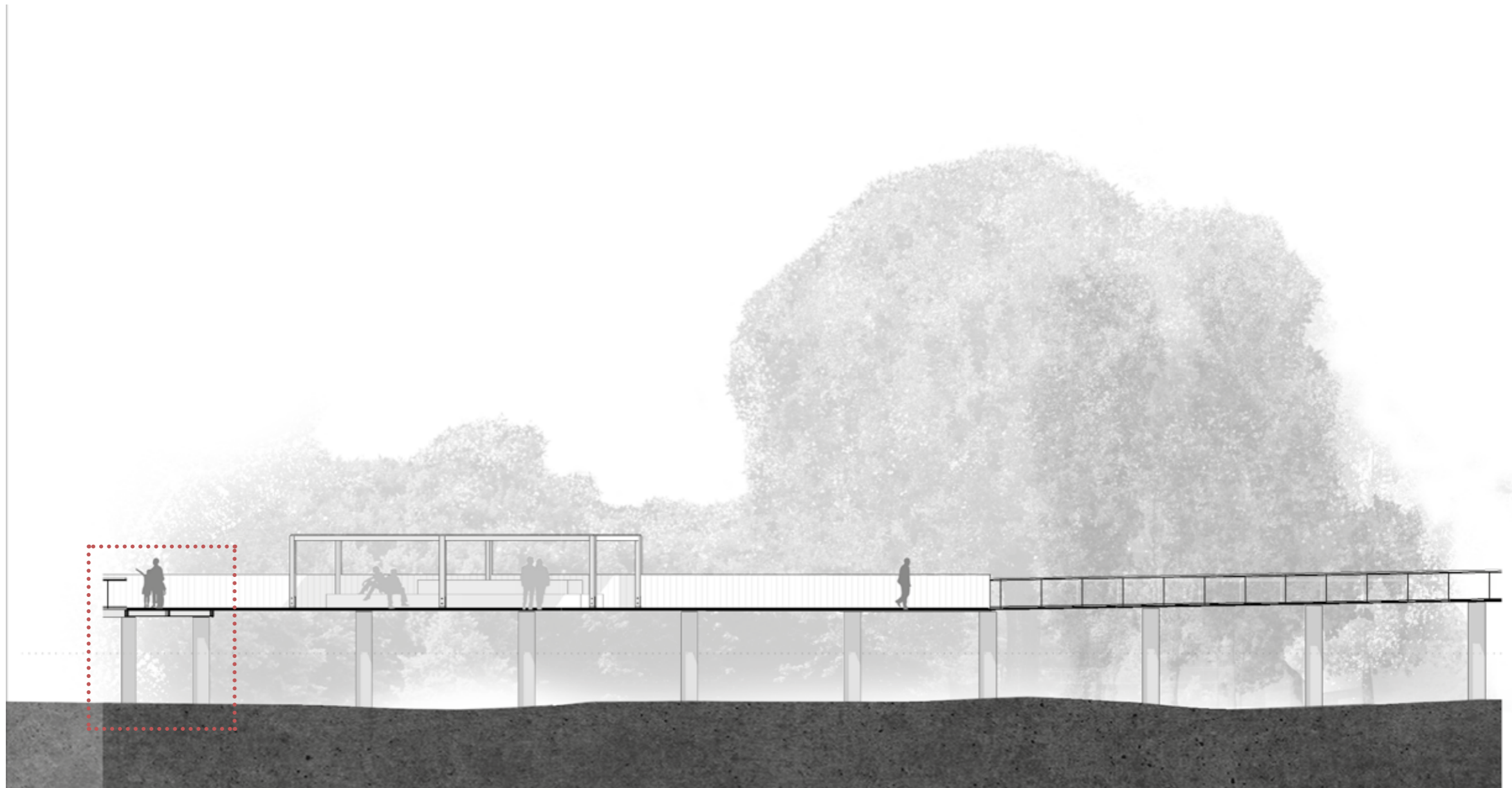

Trilhas e Mirante

Detalhe trilhas

- Estaca de concreto pré moldado **01**
- Conector pilar-viga de aço galvanizado **02**
- Pilar de MLC 40x40mm **03**
- Viga de MLC 70x200x480mm **04**
- Piso de madeira acinzentada com tratamento em autoclave **05**
- Guarda-corpo ripado em madeira carbonizada **06**
- Guarda-corpo metálico cinza **07**

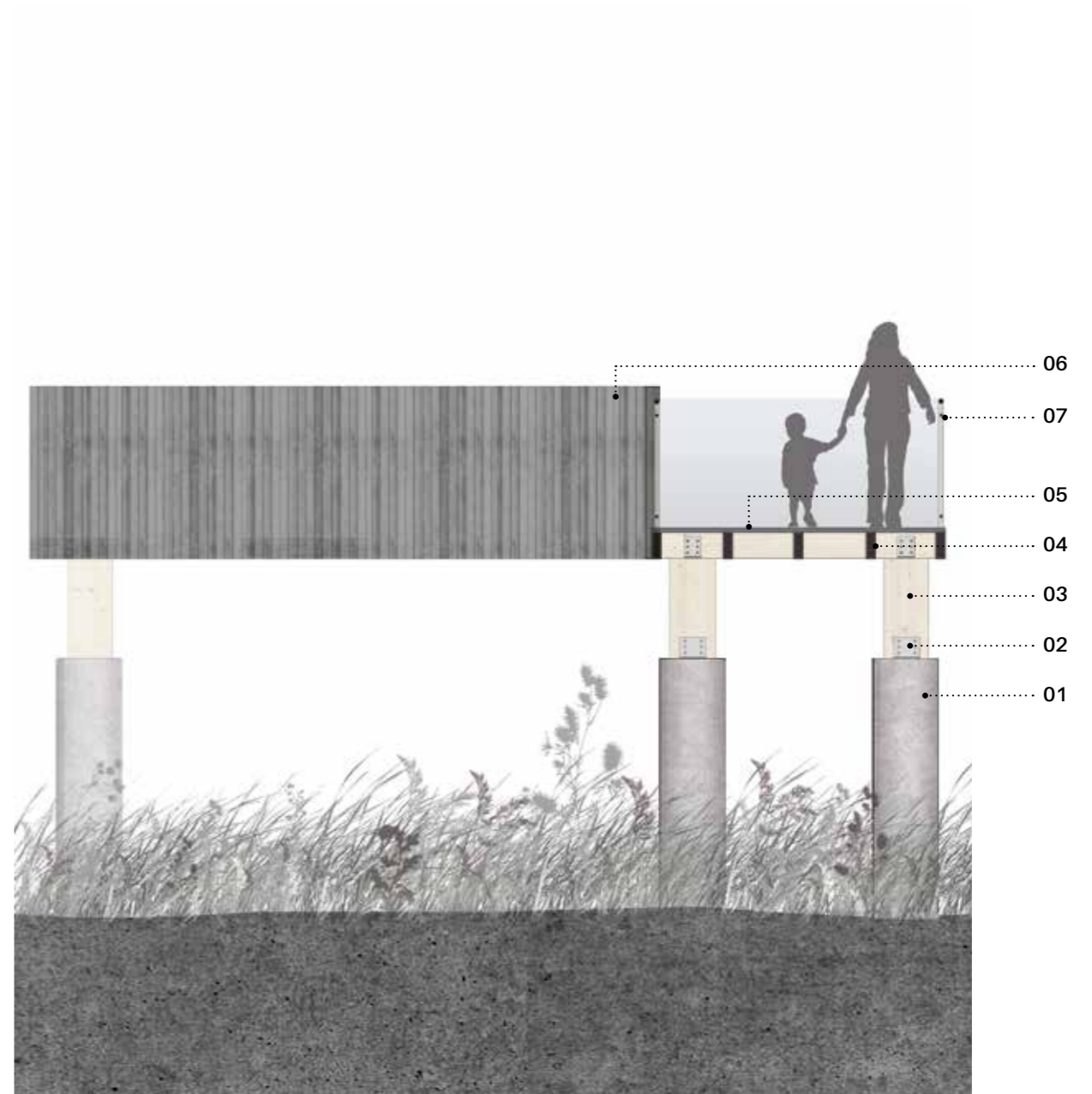

Trilhas e Mirante

Detalhe ancoradouros

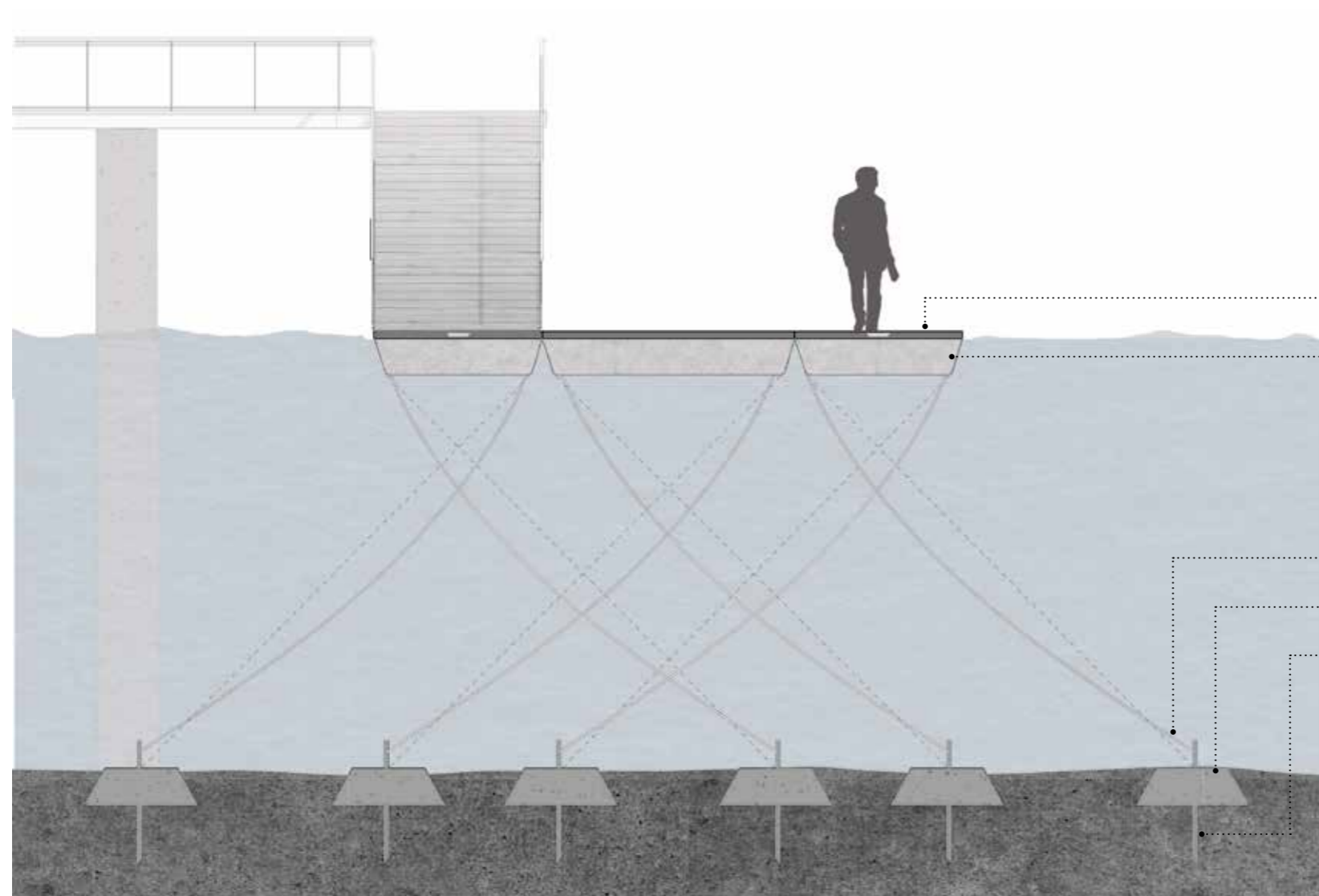

- 01 Âncora em hélice
- 02 Sapata de concreto
- 03 Cabo flexível
- 04 Módulos flutuantes de concreto Unifloat
- 05 Acabamento em madeira acinzentada

Trilhas e Mirante



Edifício-tipo

Edifício-tipo

Auditório e Centro de visitantes

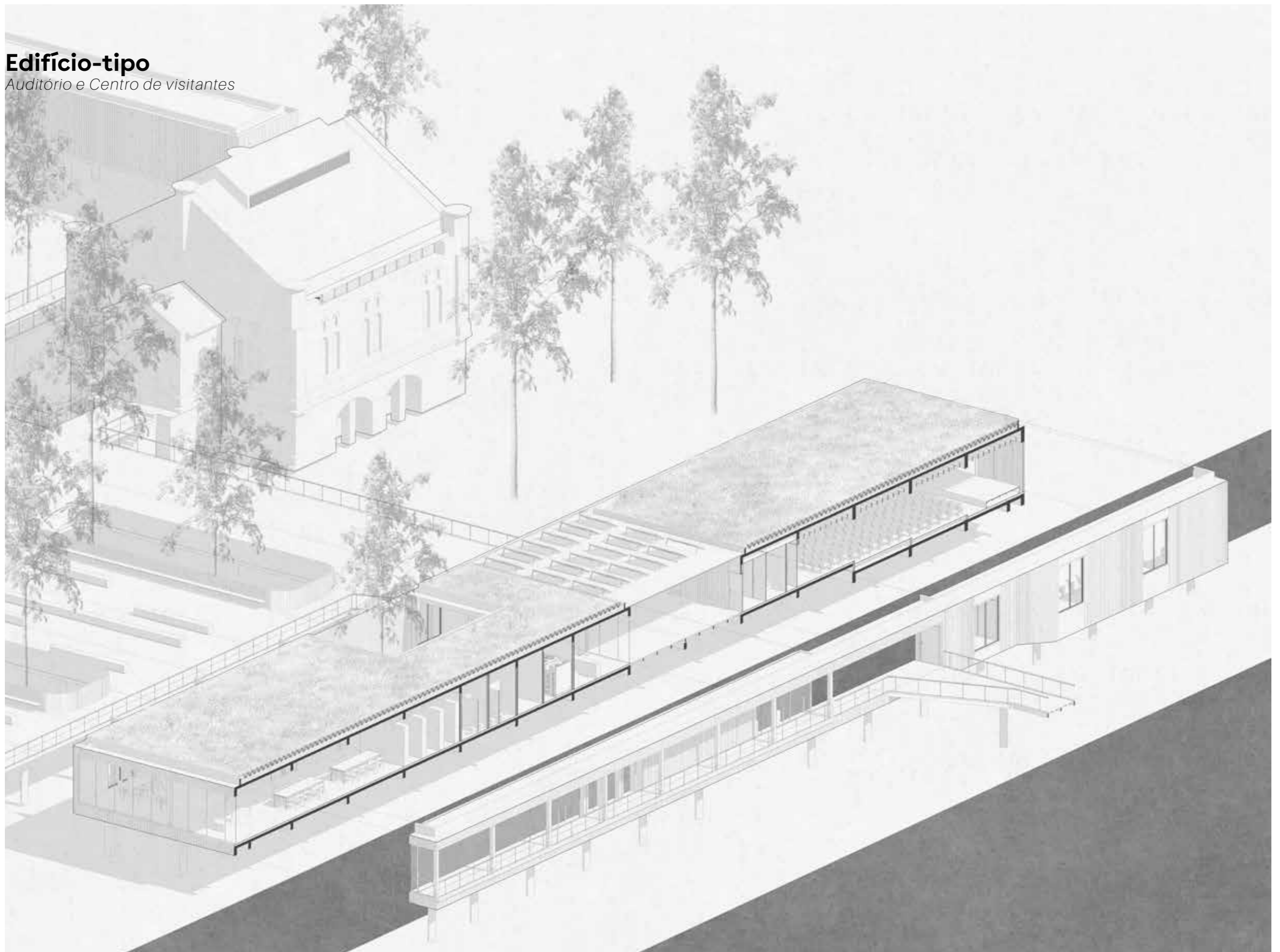

Edifício-tipo

Estrutura e construção

lajes CLT 300x480cm

Paredes em CLT

Fachada ripada com madeira carbonizada

Pilares e vigas em madeira laminada colada

lajes CLT 300x480cm

Vigas de fundação em MLC

Fundação com estacas de concreto pré moldado

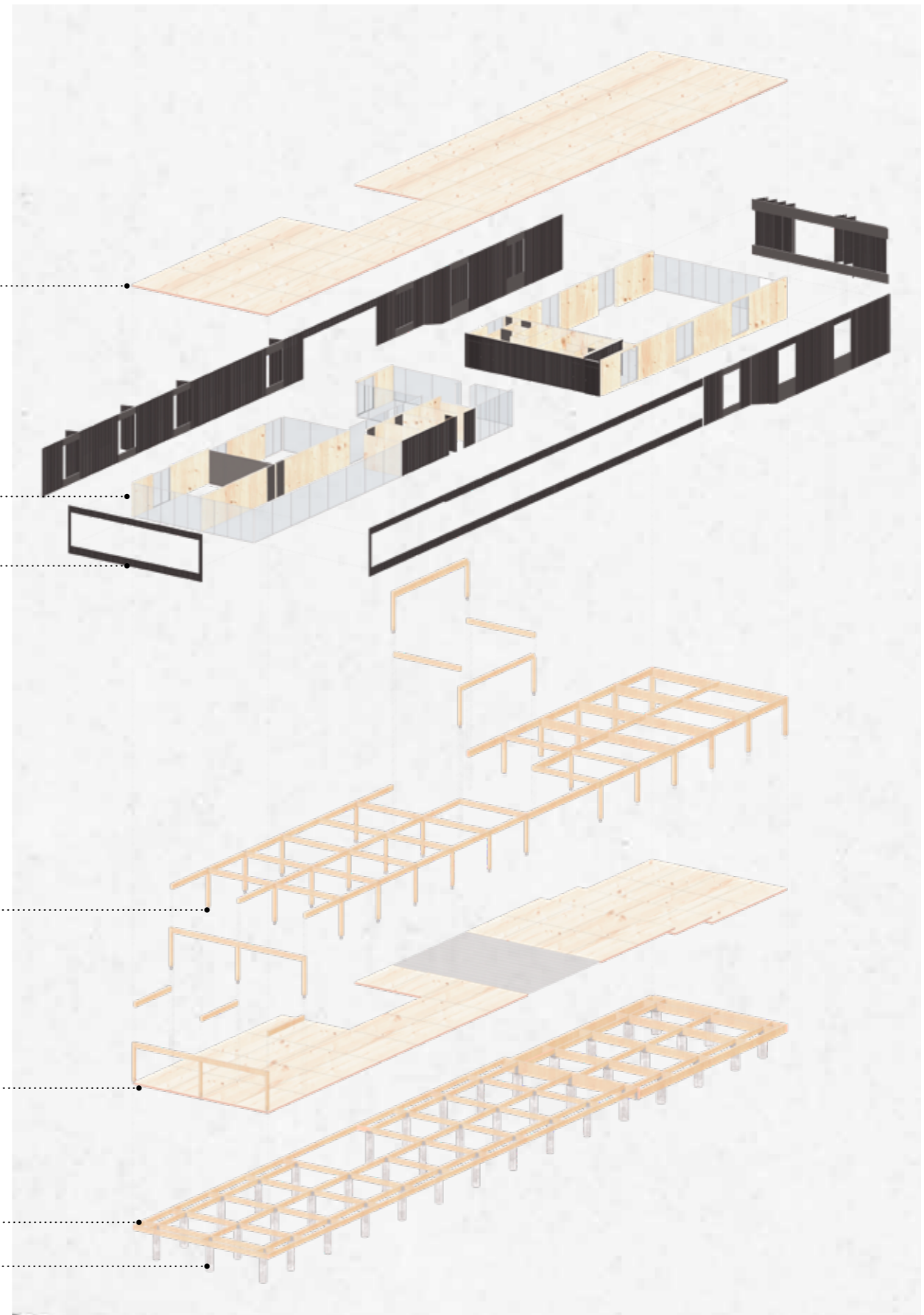

Edifício-tipo

materialidade

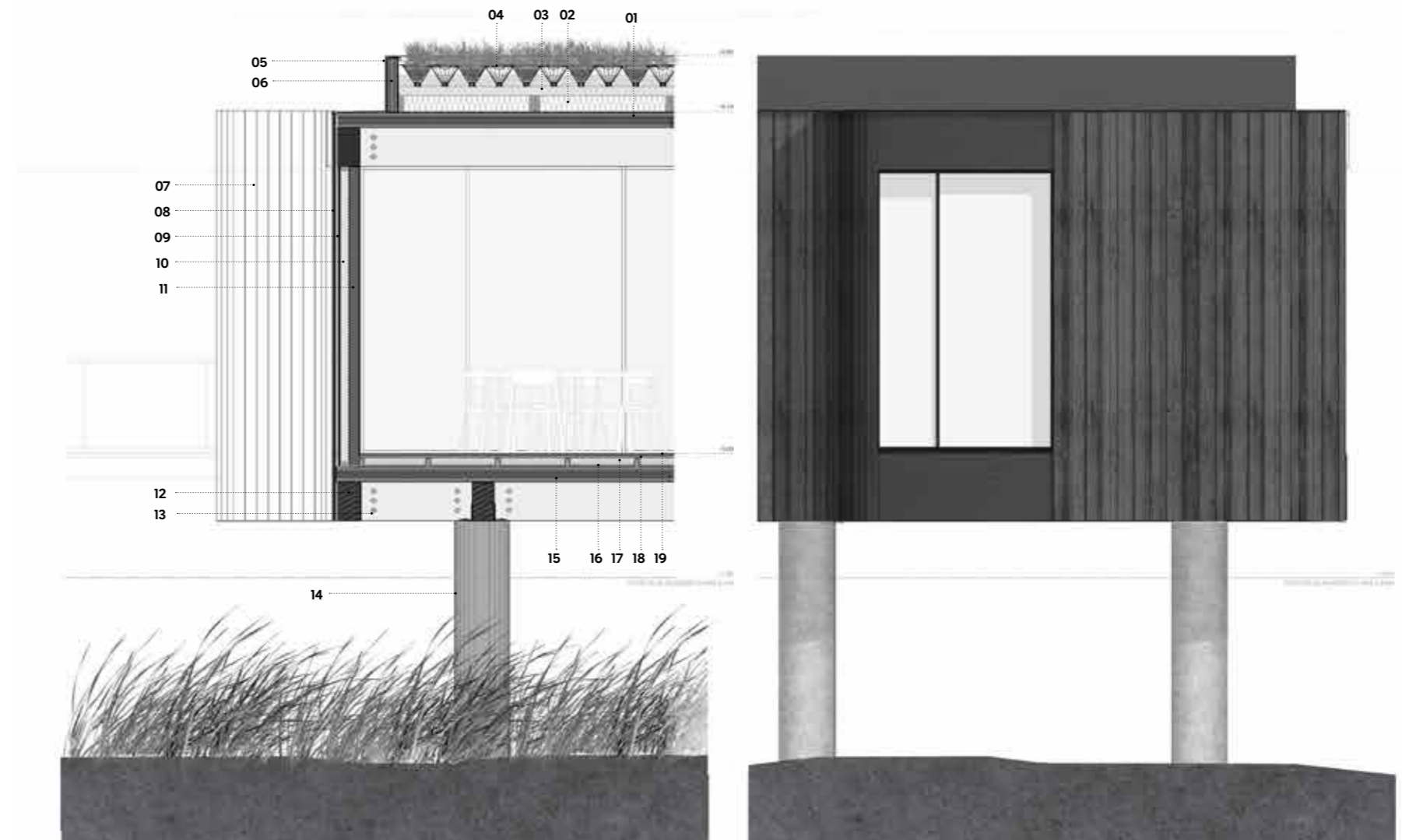

- 01. Laje CLT 5 lamelas
- 02. isolante térmico de fibra de madeira 150mm
- 03. Poliestireno extrudado (XPS) 80mm
- 04. Sistema Ecotelhado Wetland
- 05. Algeroz metálico
- 06. Platibanda em CLT 3 lamelas
- 07. Brise ripado de madeira carbonizada
- 08. Sarrafo de madeira vertical espaçado a cada 1m para garantir ventilação
- 09. Membrana de impermeabilização flexível
- 10. Isolante térmico de fibra de madeira 140mm
- 11. Parede de CLT 5 lamelas 1
- 12. Viga de Madeira Laminada Colada 35,5x25cm
- 13. Pontos de parafusagem torquada (parafusos metálicos de alta resistência inoxidável)
- 14. Fundação tipo estaca de concreto pré moldado
- 15. Laje CLT 5 lamelas
- 16. Membrana de impermeabilização flexível
- 17. Isolante térmico de fibra de madeira 60mm
- 18. OSB para nivelção do piso
- 19. Acabamento piso chapa de pinus
- 20. Sarrafo de madeira horizontal espaçado a cada 50cm para fixação do ripado da fachada
- 21. Revestimento de fachada ripado de madeira carbonizada
- 22. Pilar de Madeira Laminada Colada 25x25cm

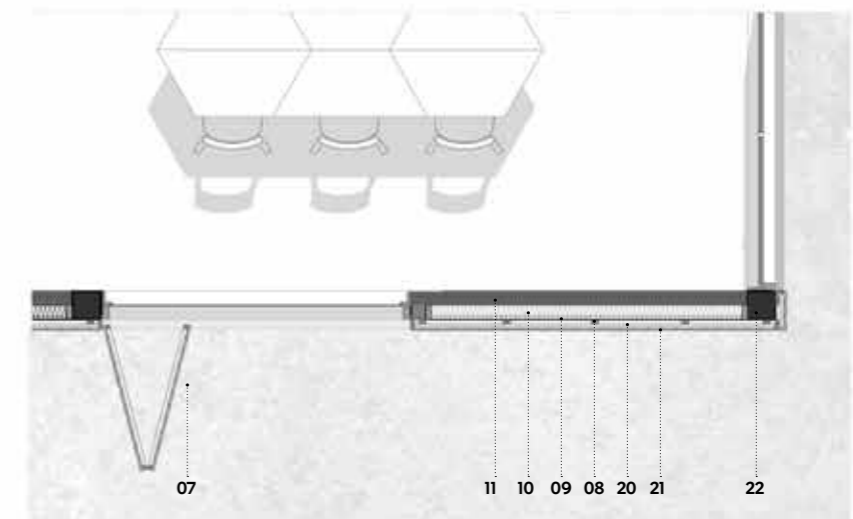

Edifício-tipo

Estratégias passivas e ativas

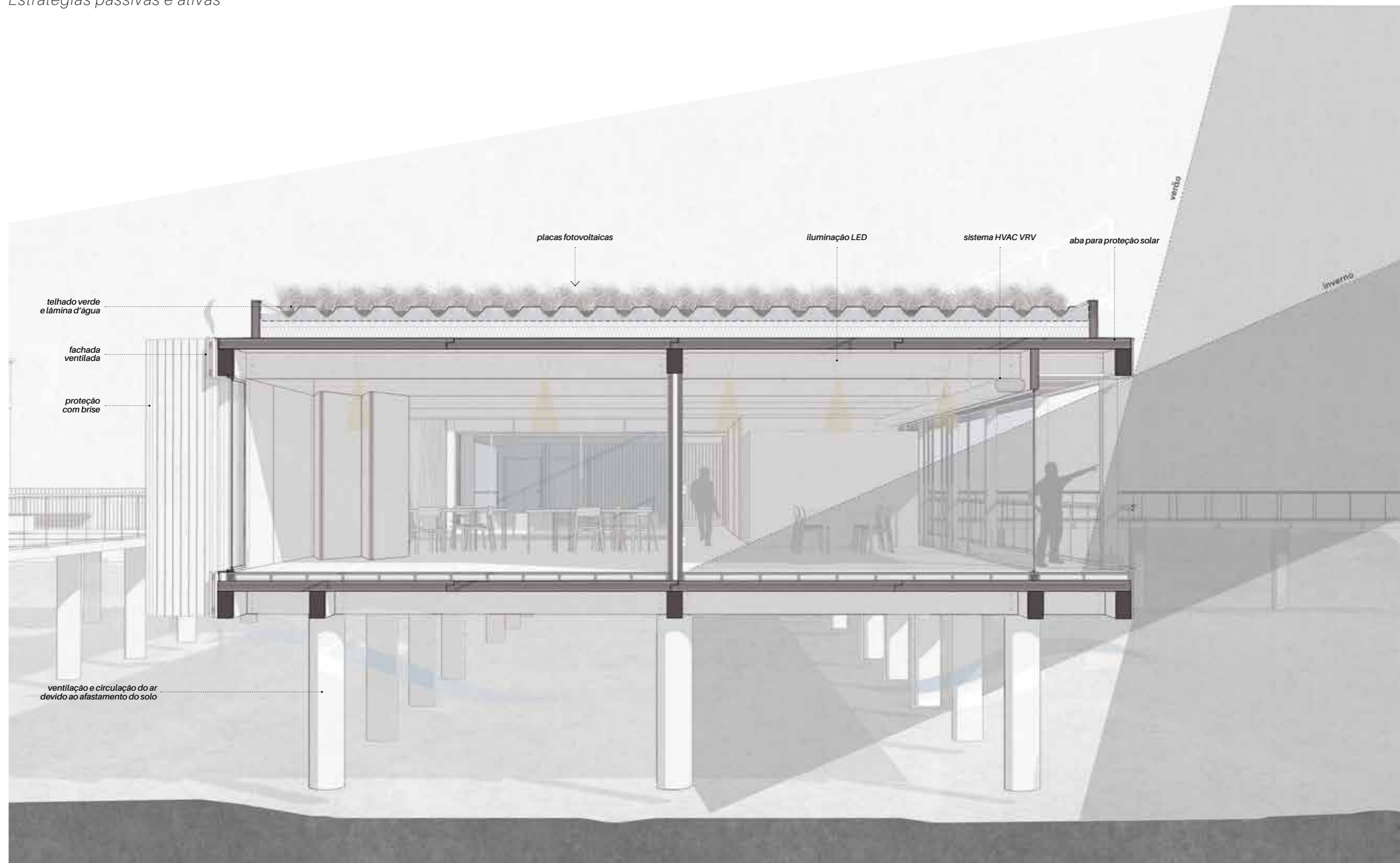

Edifício-tipo

Detalhe cobertura



Edifício-tipo

Detalhe cobertura

- 01 Sistema Ecotelhado Wetland
- 02 Membrana EPDM
- 03 Poliestireno extrudado (XPS) 80mm
- 04 Membrana Betuminosa 9mm
- 05 Isolante térmico de fibra de madeira 150mm
- 06 Membrana anti vapor
- 07 Laje CLT 5 lamelas
- 08 Parede CLT 3 lamelas
- 09 Esquadria de alumínio preto
- 10 Forro ripado de madeira
- 11 Viga de MLC 25x35,5cm
- 12 Pilar de MLC 25x25cm
- 13 Fachada ripada de madeira carbonizada
- 14 Algeroz metálico

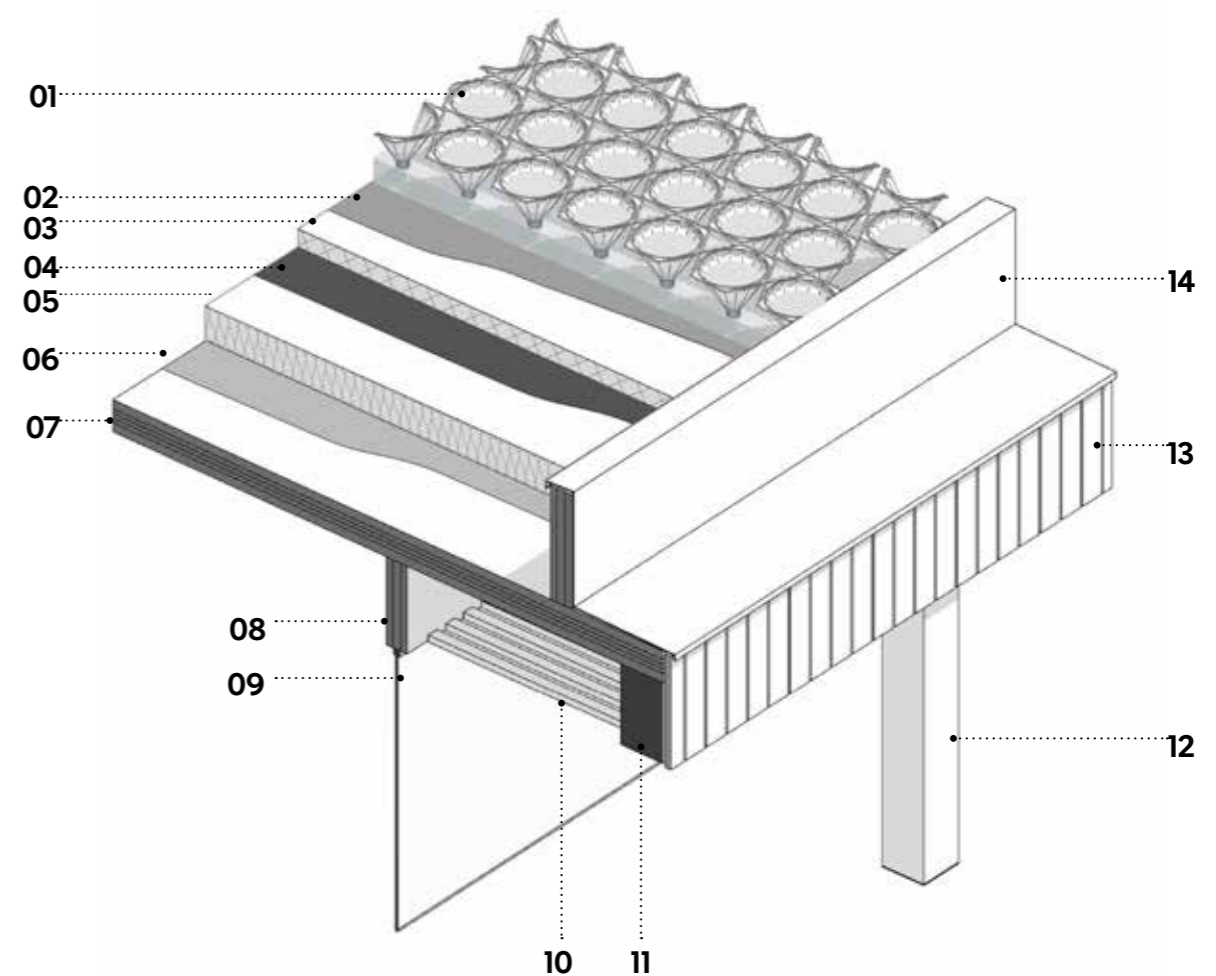

Edifício-tipo

Detalhe composição piso



Edifício-tipo

Detalhe composição piso

- 01 Laje CLT 5 lamelas
- 02 Viga de MLC 25x35,5cm
- 03 Sarrafo de madeira para estruturação do piso
- 04 Membrana de impermeabilização flexível
- 05 Isolante térmico de fibra de madeira 60mm
- 06 OSB para nivelação do piso
- 07 Acabamento piso chapa de pinus
- 08 Pilar de MLC 25x25cm
- 09 Parede CLT 3 lamelas
- 10 Isolante térmico de fibra de madeira 150mm
- 11 Revestimento de fachada de ripado de madeira laminada colada

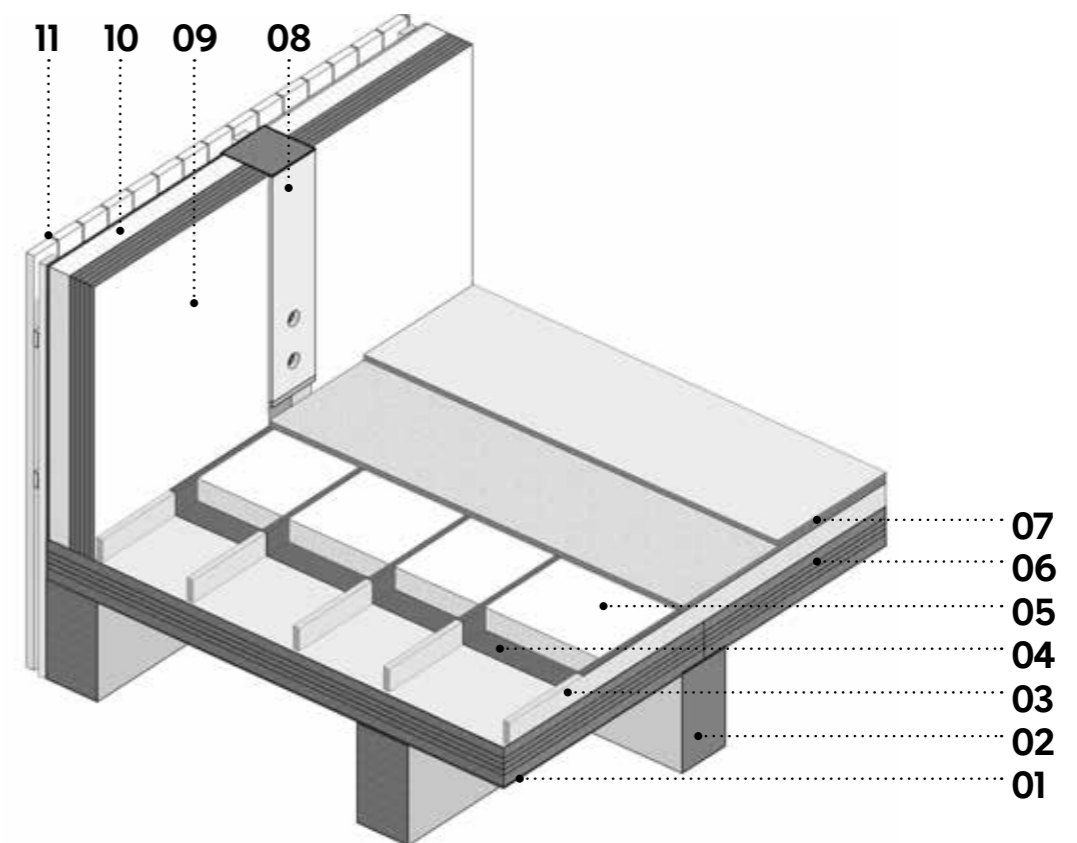

Edifício-tipo

Detalhe parede externa



Edifício-tipo

Detalhe parede externa

- 01 Alçargoz metálico
- 02 Ripas de madeira carbonizada
- 03 Sarrafo de madeira vertical espaçado a cada 1m para garantir ventilação
- 04 Sarrafo de madeira horizontal espaçado a cada 50cm para fixação do ripado da fachada
- 05 Membrana de impermeabilização flexível
- 06 Isolante térmico de fibra de madeira 140mm
- 07 Parede de CLT 5 lamelas

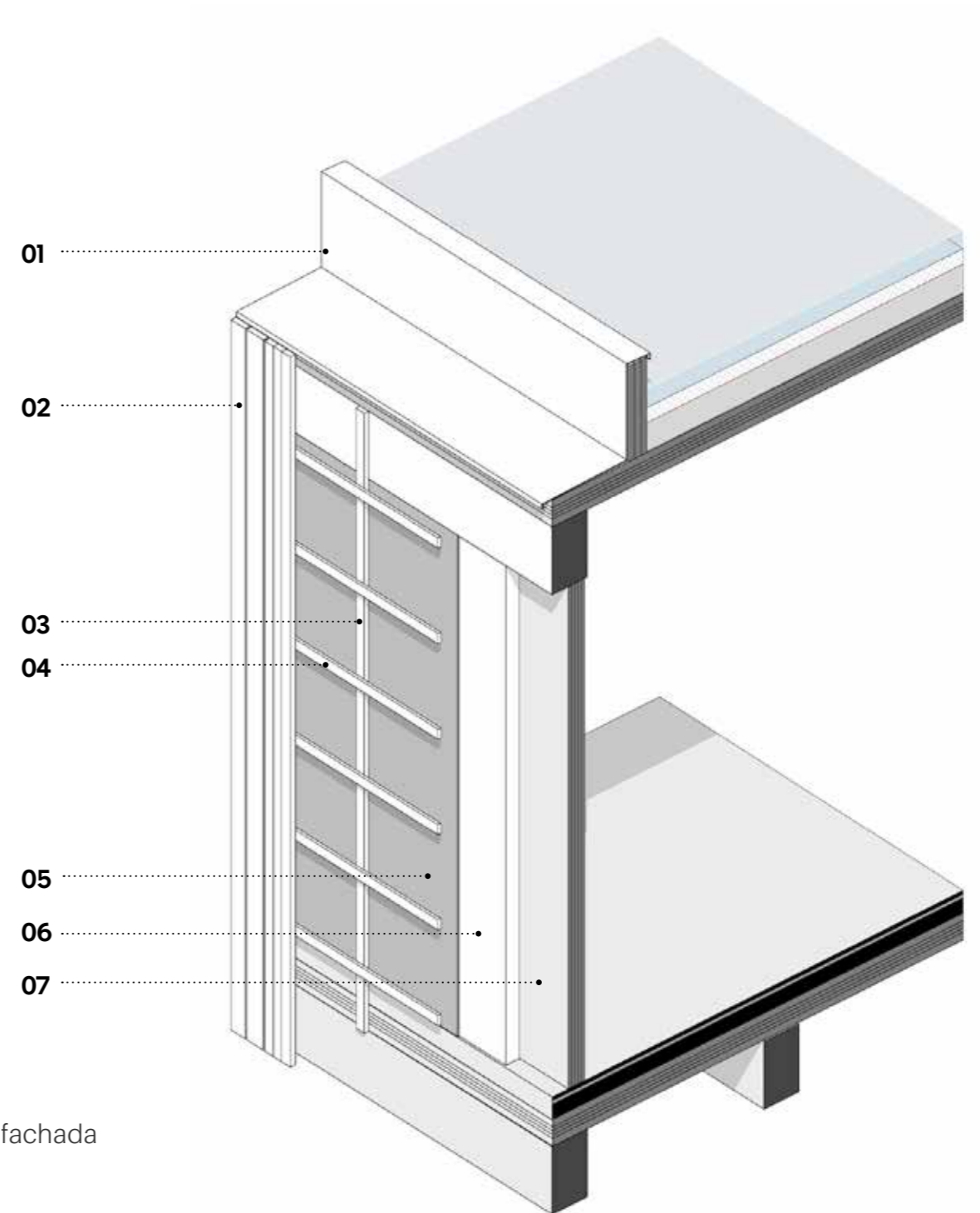

Edifício-tipo

Detalhe estrutura de MLC



Edifício-tipo

Detalhe estrutura de MLC

- 01 Pilar de MLC 25x25cm
- 02 Pontos de parafusagem torqueada (parafusos metálicos de alta resistência inoxidável)
- 03 Cava longitudinal para encaixe do conector metálico
- 04 Viga de MLC 35,5x25cm
- 05 Conector metálico com moldura para topo e pontos de parafusagem (parabolt metálico de alta resistência inoxidável)
- 06 Conector metálico pilar-viga com placa metálica para evitar infiltração de água
- 07 Fundação tipo estaca de concreto pré moldado
- 08 Conector metálico pilar-viga embutido

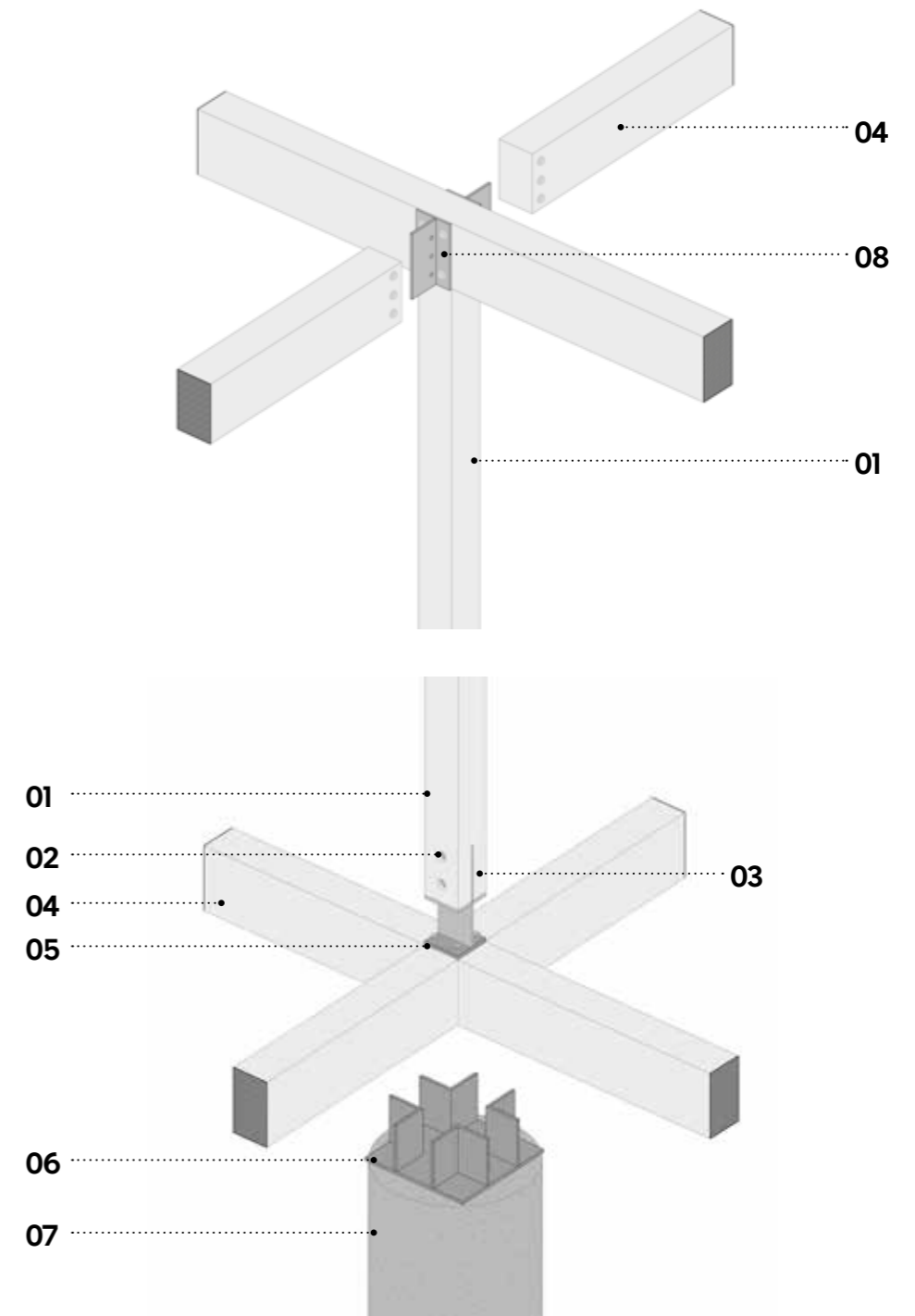



Memória



Memória



Memória



Memória



Memória



Memória



Conhecimento



Conhecimento



Paisagem



Trilhas e Mirante



É preciso reforçar a importância e o papel que os setores ambiental, cultural e educacional representam para o desenvolvimento de uma nação saudável (física e mentalmente).

Devemos valorizar nosso patrimônio, nosso passado e nossa história.

O Complexo Cultural, Ambiental e Científico Ilha da Casa da Pólvora busca fazer essa reflexão, trazendo “à superfície” partes da nossa história e identidade por ora esquecidas.

Obrigada!